

VOGEL

TLEVEN
INSTRUMENTS

*quando la
tradizione
incontra la tecnologia*

PROMO 2021
ristampa PROMO 2020

NUOVO SITO WEB: WWW.VOGEL.IT

Validità fino al 31.05.2021 - Prezzi netti agli utilizzatori - IVA esclusa

Correzioni, modifiche e validità vedete il nostro sito www.vogel.it

Per tutti i prodotti non in promo è valido il listino 2020

Codici in rosso, in esaurimento - Codici con (E) alternativa economica



PAGINA 4/5



PAGINA 6



PAGINA 7/8



PAGINA 8/10

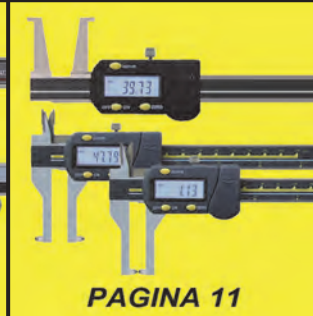

PAGINA 11



PAGINA 12

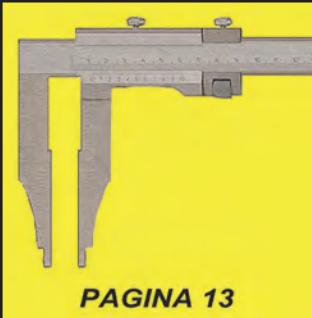

PAGINA 13



PAGINA 14/15/16

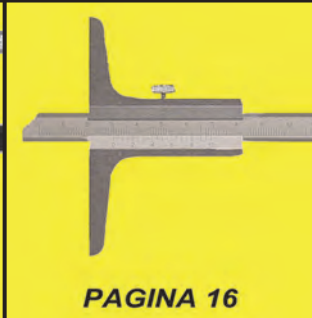

PAGINA 16



PAGINA 16/17



PAGINA 18/19



PAGINA 18/19



PAGINA 20/21



PAGINA 22



PAGINA 23



PAGINA 24



PAGINA 25



PAGINA 25

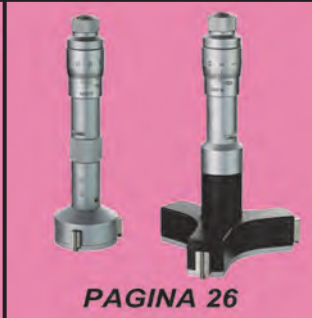

PAGINA 26

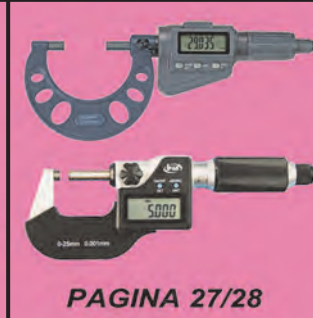

PAGINA 27/28



PAGINA 29

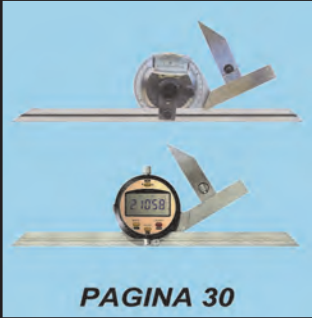

PAGINA 30



PAGINA 30



PAGINA 31



PAGINA 32/33



PAGINA 34



PAGINA 35



PAGINA 36/37



PAGINA 38/39/40

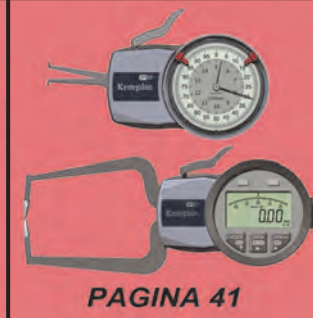

PAGINA 41



PAGINA 42/43



PAGINA 43



PAGINA 44



PAGINA 45



PAGINA 45



PAGINA 46



PAGINA 47



PAGINA 48



PAGINA 48



PAGINA 49



PAGINA 50

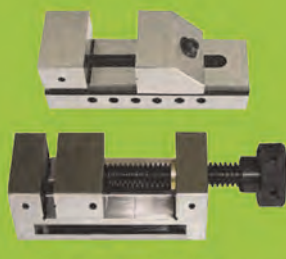

PAGINA 51



PAGINA 52



PAGINA 53



PAGINA 54



PAGINA 54



PAGINA 55



PAGINA 56



PAGINA 56



PAGINA 57



PAGINA 58



PAGINA 59

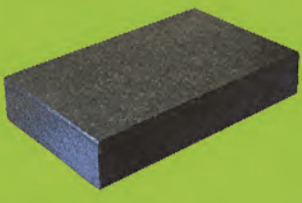

PAGINA 60



PAGINA 61



PAGINA 62



PAGINA 63



PAGINA 64



PAGINA 65



PAGINA 66/67



PAGINA 68



PAGINA 69



PAGINA 70/71



PAGINA 72



PAGINA 72



PAGINA 73



PAGINA 73/74



PAGINA 74



PAGINA 75



PAGINA 76

Certificazioni e Rapporti di taratura

ACCREDIA
L'ENTE ITALIANO DI ACCREDITAMENTO

PAGINA 77/83



da € 13,00

001.108

Codice	Utile	Becchi	Letture	Prezzo €
001.108	150	40	0,05	13,00
001.110	200	50	0,05	20,50
001.112	300	60	0,05	35,50

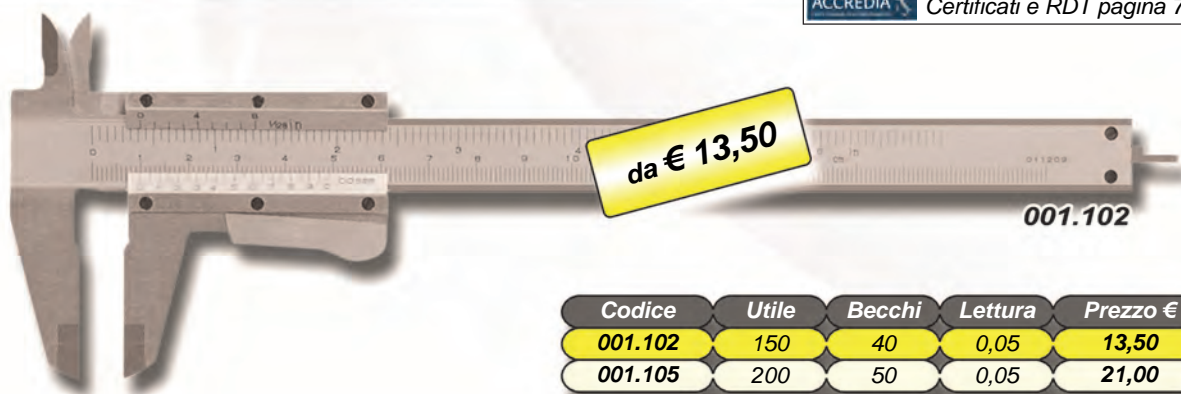

da € 13,50

001.102

Codice	Utile	Becchi	Letture	Prezzo €
001.102	150	40	0,05	13,50
001.105	200	50	0,05	21,00

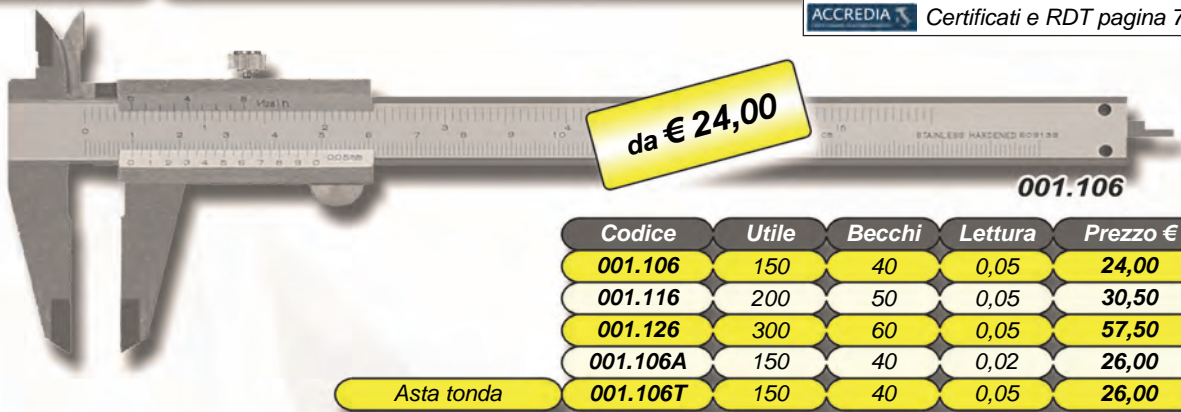

da € 24,00

001.106

Codice	Utile	Becchi	Letture	Prezzo €	
001.106	150	40	0,05	24,00	
001.116	200	50	0,05	30,50	
001.126	300	60	0,05	57,50	
001.106A	150	40	0,02	26,00	
Asta tonda	001.106T	150	40	0,05	26,00



da € 25,00

001.103

Codice	Utile	Becchi	Letture	Prezzo €	
001.103	150	40	0,05	25,00	
001.113	200	50	0,05	32,00	
001.123	300	60	0,05	59,50	
001.103A	150	40	0,02	27,50	
Asta tonda	001.103T	150	40	0,05	27,50

Calibri monoblocco Top 1/20° e 1/50° - Bloccaggio a vite superiore - Asta rettangolare

Catalogo 1/6

ACCREDIA Certificati e RDT pagina 78

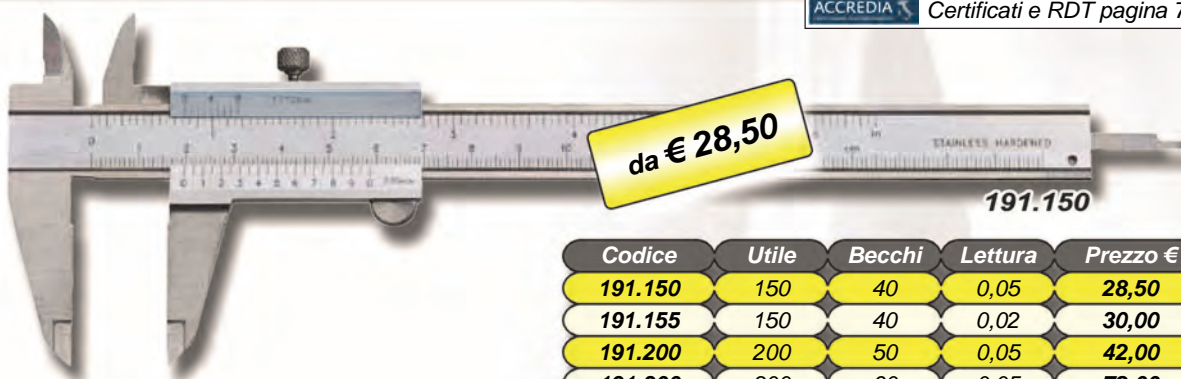

Codice	Utile	Becchi	Lettura	Prezzo €
191.150	150	40	0,05	28,50
191.155	150	40	0,02	30,00
191.200	200	50	0,05	42,00
191.300	300	60	0,05	72,00

Calibri monoblocco Top 1/20° e 1/50° - Bloccaggio rapido a pulsante - Asta rettangolare

Catalogo 1/6

ACCREDIA Certificati e RDT pagina 78

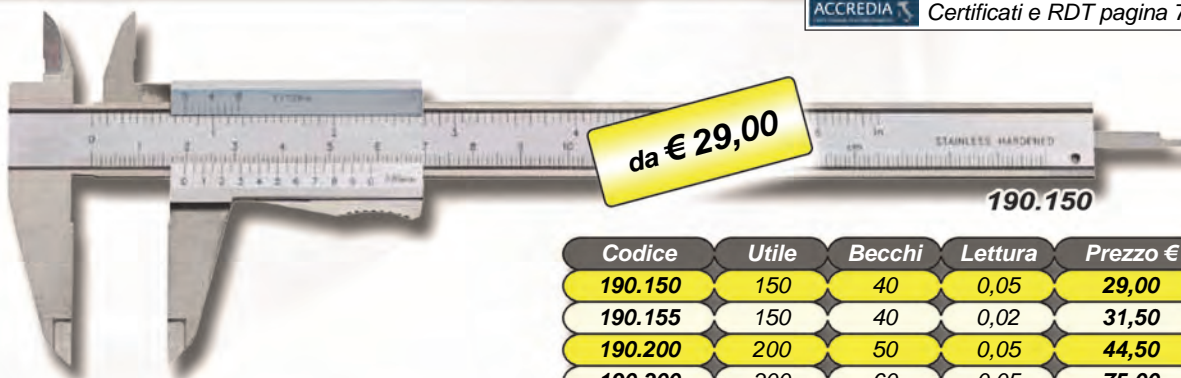

Codice	Utile	Becchi	Lettura	Prezzo €
190.150	150	40	0,05	29,00
190.155	150	40	0,02	31,50
190.200	200	50	0,05	44,50
190.300	300	60	0,05	75,00

Calibri monoblocco 1/20° - Bloccaggio a rotella

Catalogo 1/7

ACCREDIA Certificati e RDT pagina 78



Codice	Utile	Becchi	Lettura	Prezzo €
001.240	150	40	0,05	39,00

Minicalibri monoblocco 1/20° - Bloccaggio a vite

Catalogo 1/9

ACCREDIA Certificati e RDT pagina 78



Codice	Utile	Becchi	Lettura	Prezzo €
001.101	100	30	0,05	24,00



Catalogo 1/12 Calibri ad orologio monoblocco 1/100° - Bloccaggio a vite - Rotella - Asta rettangolare nera

ACCREDIA Certificati e RDT pagina 78



Codice	Utile	Becchi	Letture	Prezzo €
218.501	150	40	0,01	58,00
218.502	200	50	0,01	75,00
218.503	300	60	0,01	127,50

Catalogo 1/12 Calibri ad orologio monoblocco 1/50° - Bloccaggio a vite - Rotella - Asta rettangolare nera

ACCREDIA Certificati e RDT pagina 78



Codice	Utile	Becchi	Letture	Prezzo €
217.501	150	40	0,02	48,00
217.502	200	50	0,02	67,50
217.503	300	60	0,02	112,00

Catalogo 1/13 Calibri ad orologio monoblocco 1/100° - Bloccaggio a vite - Senza rotella - Asta rettangolare

ACCREDIA Certificati e RDT pagina 78



Codice	Utile	Becchi	Letture	Prezzo €
213.504G	200	50	0,01	65,00

Catalogo 1/13 Calibri ad orologio monoblocco 1/50° - Bloccaggio a vite - Senza rotella - Asta rettangolare

ACCREDIA Certificati e RDT pagina 78



Codice	Utile	Becchi	Letture	Prezzo €
213.501G	150	40	0,02	43,00
213.502G	200	50	0,02	59,00
213.503G	300	60	0,02	92,00

Calibri digitali auto-on - Memorizzazione ultima misura - ABS - Rotella

Catalogo 1/13

ACCREDIA Certificati e RDT pagina 78



Codice	Utile	Becchi	Lettura	Prezzo €
009.141	150	40	0,01	27,00
009.142	200	50	0,01	41,00

Calibri digitali per mancini - Bloccaggio a vite - Asta rettangolare - Rotella

Catalogo 1/18

ACCREDIA Certificati e RDT pagina 78



Codice	Utile	Becchi	Lettura	Prezzo €
009.158	150	40	0,01	66,00

Calibri digitali - Asta nera - On/off - mm/inch - Zero - Con rotella

Catalogo 1/14

ACCREDIA Certificati e RDT pagina 78



Codice	Utile	Becchi	Lettura	Prezzo €
009.184	150	40	0,01	26,00

Calibri con bloccaggio rapido a pulsante - Senza rotella - Asta rettangolare

Catalogo 1/18

ACCREDIA Certificati e RDT pagina 78



Codice	Utile	Becchi	Lettura	Prezzo €
009.091	150	40	0,01	54,00
009.092	200	50	0,01	73,00



009.031

Codice	Utile	Becchi	Lettura	Prezzo €
009.031	150	40	0,01	37,50
009.032	200	50	0,01	65,50
009.033	300	60	0,01	95,00
Elettronica preset 009.031P	150	40	0,01	44,00

Elettronica preset



009.181

Codice	Utile	Becchi	Lettura	Prezzo €
009.181	150	40	0,01	44,50
009.182	200	45	0,01	69,50
009.183	300	60	0,01	121,50



009.048

Codice	Utile	Becchi	Lettura	Prezzo €
009.048	150	40	0,01	67,00
009.049	200	50	0,01	99,50



009.045

Codice	Utile	Becchi	Lettura	Prezzo €
009.045	150	40	0,01	95,50

Calibri digitali senza limite di velocità - Absolut System - Asta rettangolare - Cassa metallica **Catalogo 1/19**

ACCREDIA Certificati e RDT pagina 78

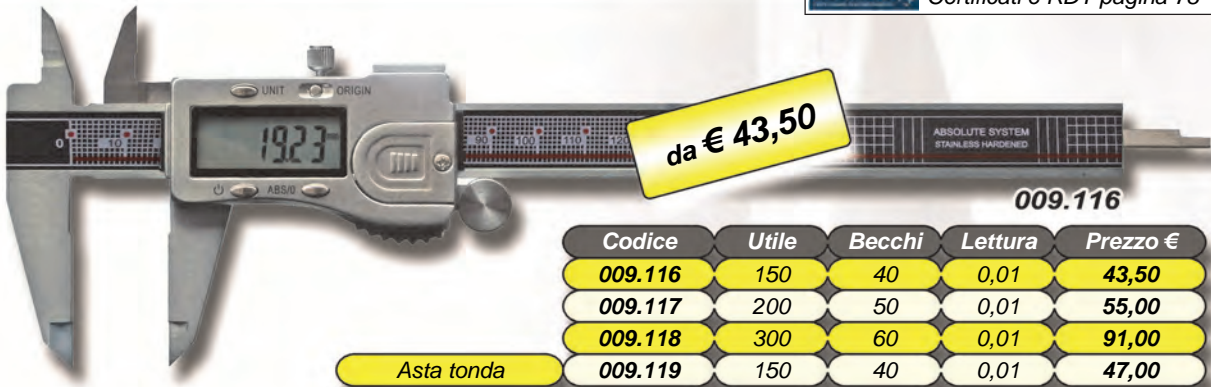

Codice	Utile	Becchi	Lettura	Prezzo €
009.116	150	40	0,01	43,50
009.117	200	50	0,01	55,00
009.118	300	60	0,01	91,00
009.119	150	40	0,01	47,00

Asta tonda

Calibri digitali Top con cassa metallica - Display XXL - Rotella - Asta rettangolare **Catalogo 1/19**

ACCREDIA Certificati e RDT pagina 78

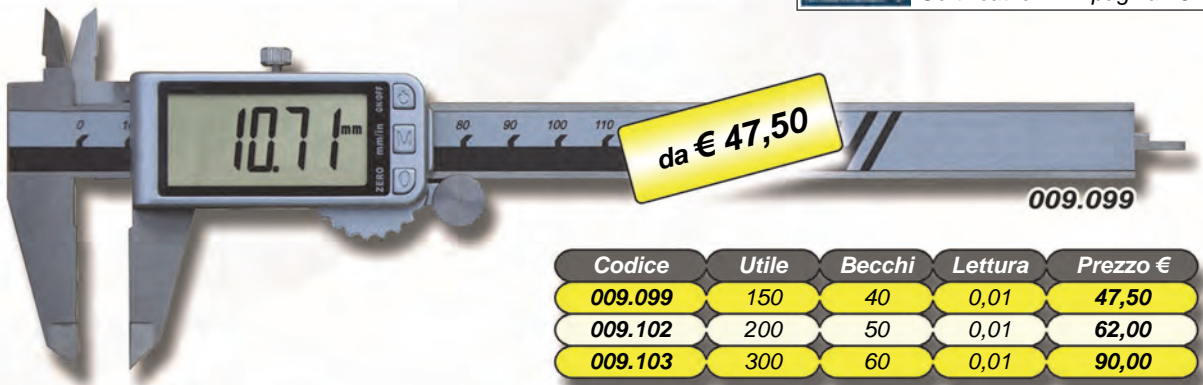

Codice	Utile	Becchi	Lettura	Prezzo €
009.099	150	40	0,01	47,50
009.102	200	50	0,01	62,00
009.103	300	60	0,01	90,00

Calibri digitali con encoder e cremagliera - IP67 - Bloccaggio a vite - Asta rettangolare **Fuori catalogo**

ACCREDIA Certificati e RDT pagina 78

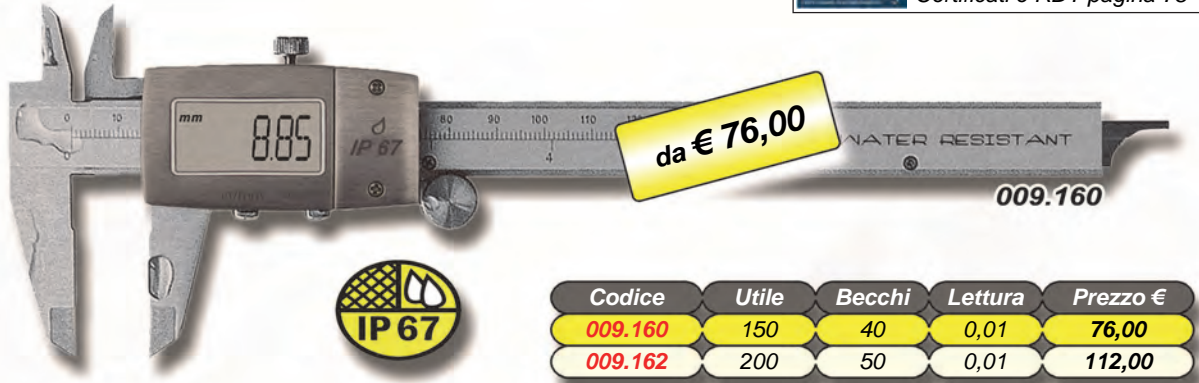

Codice	Utile	Becchi	Lettura	Prezzo €
009.160	150	40	0,01	76,00
009.162	200	50	0,01	112,00

Calibri digitali auto on/off - Memorizzazione ultima misura - IP67 - Asta rettangolare **Catalogo 1/20**

ACCREDIA Certificati e RDT pagina 78



Codice	Utile	Becchi	Lettura	Prezzo €
215.515	150	40	0,01	94,00
215.520	200	50	0,01	127,00
215.530	200	60	0,01	185,00

Disponibili anche con Bluetooth

ACCREDIA Certificati e RDT pagina 78



Codice	Utile	Becchi	Letture	Prezzo €
215.715	150	40	0,01	107,00
215.720	200	50	0,01	139,50
215.730	300	60	0,01	188,00
Asta tonda 215.717	150	40	0,01	109,50



Elettronica Sylvac

ACCREDIA Certificati e RDT pagina 78



Codice	Utile	Becchi	Letture	Prezzo €
220.806	150	40	0,01	239,00



CONTROLLO DI FORZA - ottimale 8N

ACCREDIA Certificati e RDT pagina 78

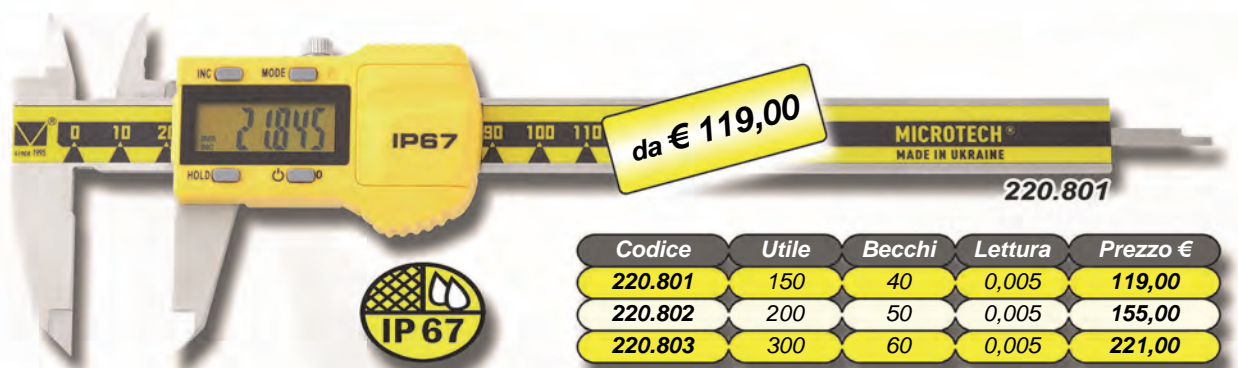

Codice	Utile	Becchi	Letture	Prezzo €
220.801	150	40	0,005	119,00
220.802	200	50	0,005	155,00
220.803	300	60	0,005	221,00



Astuccio in alluminio (220.795P in PVC)

ACCREDIA Certificati e RDT pagina 78



Codice	Utile	Becchi	Letture	Prezzo €
220.795P	150	40	0,01	119,00
220.795	150	40	0,01	124,00
220.796	200	50	0,01	205,00
220.797	300	60	0,01	280,00



ACCREDIA Certificati e RDT pagina 78



Codice	Utile	Piedini	Lettura	Prezzo €
009.714	3-140	4 x L3	0,01	134,00

ACCREDIA Certificati e RDT pagina 78



Codice	Utile	Becchi	Lettura	Prezzo €
009.257	10-160	26	0,01	116,00
009.258	10-210	28	0,01	153,50

ACCREDIA Certificati e RDT pagina 78



VIDEO ISTRUZIONI



Codice	Utile	Becchi	Spessore	Prezzo €
009.709	150	50	5+5	148,50
009.729	200	83	7+7	220,00

ACCREDIA Certificati e RDT pagina 78



Codice	Utile	Becchi	Lettura	Prezzo €
009.165	150	70/40	0,01	99,00
009.166	200	80/40	0,01	123,00



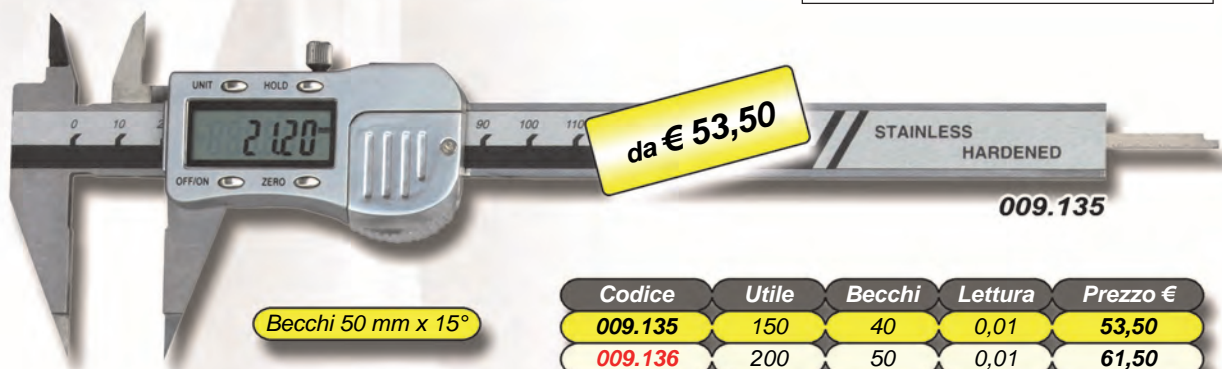

Becchi 50 mm x 15°

Codice	Utile	Becchi	Lettura	Prezzo €
009.135	150	40	0,01	53,50
009.136	200	50	0,01	61,50

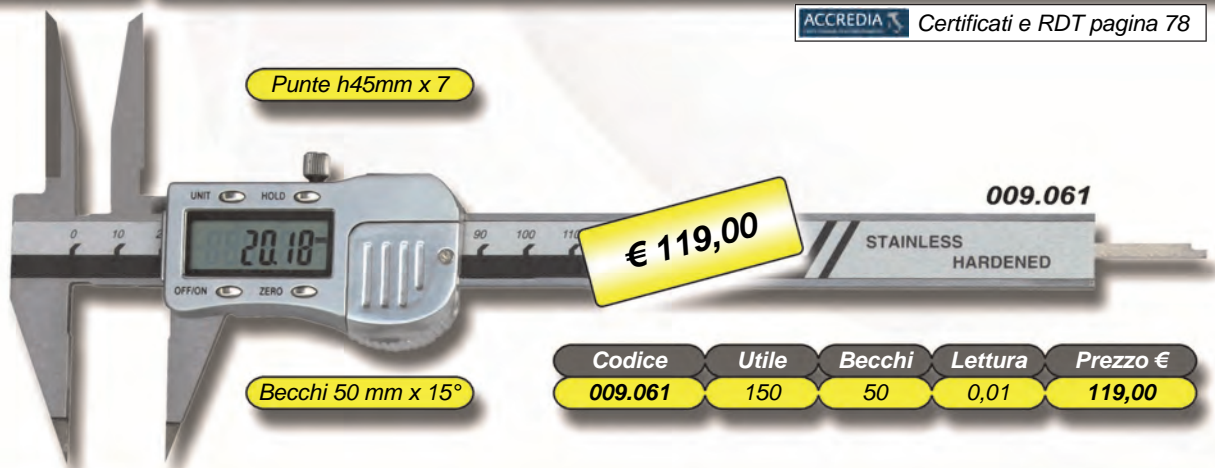

Punte h45mm x 7

Becchi 50 mm x 15°

Codice	Utile	Becchi	Lettura	Prezzo €
009.061	150	50	0,01	119,00



Spess. 0,75 x h20mm

Codice	Utile	Becchi	Lettura	Prezzo €
009.067	150	40	0,01	67,00



Codice	Utile	Becchi	Lettura	Prezzo €
009.167	12-150	60	0,01	110,00
009.168	14-200	75	0,01	136,00



Becchi standard



Codice	Utile	Becchi	Lettura	Prezzo €
001.403	300	90	0,02	73,00
001.406	500	100	0,02	88,00
* 001.495E	500	100	0,02	77,00
001.407	600	100	0,02	99,00
001.404	800	150	0,02	296,00
001.411	1000	150	0,02	299,00
* 001.496E	1000	150	0,02	246,00
001.412	1000	200	0,02	348,00
001.415	1500	200	0,02	662,00
* 001.497E	1500	200	0,02	584,00
001.420N	2000	200	0,02	899,00

Becchi lunghi

001.408	500	150	0,02	113,00
001.409	600	150	0,02	122,00
001.405N	600	300	0,02	190,00
001.413	1000	300	0,02	370,00
001.410N	1000	500	0,02	654,00
001.421	2000	300	0,02	948,00
001.425	2500	300	0,02	1340,00
001.430	3000	300	0,02	1670,00



Imballo in astuccio di legno non contestabile in caso di rottura durante il trasporto



Becchi standard



Codice	Utile	Becchi	Lettura	Prezzo €
001.630	200	60	0,02	45,50
001.631	250	80	0,02	91,50
001.633	300	90	0,02	110,00
* 001.591E	300	90	0,02	80,00
001.634	500	100	0,02	187,00
* 001.592E	500	100	0,02	131,00
001.636	600	100	0,02	201,00
001.639	1000	150	0,02	548,00
001.640	1500	200	0,02	935,00
001.645	2000	200	0,02	1164,00

Becchi lunghi

001.762	300	150	0,02	187,50
001.635	500	150	0,02	232,00
001.769	500	250	0,02	395,00
001.637	600	150	0,02	281,00
001.774	600	300	0,02	567,00
001.775	1000	300	0,02	793,00
001.776	1000	500	0,02	1247,00
001.646	2000	300	0,02	1960,00
001.647	3000	300	0,02	2852,00



Imballo in astuccio di legno non contestabile in caso di rottura durante il trasporto

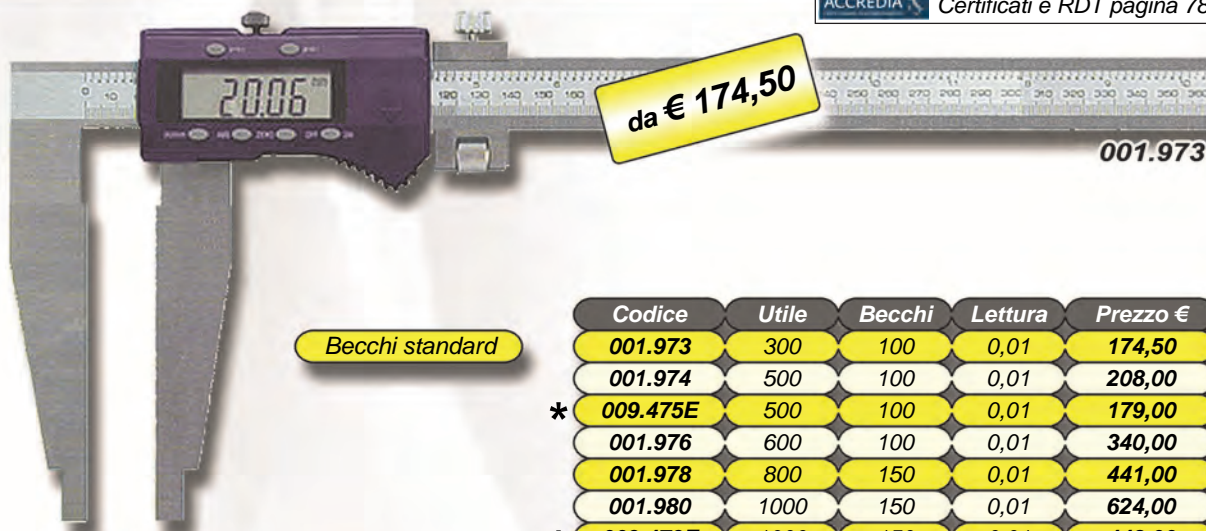

Becchi standard

Codice	Utile	Becchi	Letture	Prezzo €
001.973	300	100	0,01	174,50
001.974	500	100	0,01	208,00
* 009.475E	500	100	0,01	179,00
001.976	600	100	0,01	340,00
001.978	800	150	0,01	441,00
001.980	1000	150	0,01	624,00
* 009.479E	1000	150	0,01	448,00



Becchi lunghi

001.972	300	150	0,01	219,00
001.975	500	150	0,01	257,00
* 009.477E	500	150	0,01	225,00
001.975L	500	200	0,01	310,00
001.977	600	150	0,01	373,00
001.977L	600	200	0,01	414,00
001.979	600	300	0,01	549,00
001.980L	1000	300	0,01	1109,00
001.981	1500	200	0,01	1240,00
001.982	2000	200	0,01	1760,00
001.982L	2000	300	0,01	1800,00

Imballo in astuccio di legno non contestabile in caso di rottura durante il trasporto



Becchi standard

Codice	Utile	Becchi	Letture	Prezzo €
* 001.941	300	100	0,01	239,00
001.943	500	100	0,01	325,00
001.942	600	100	0,01	452,00
001.948	1000	150	0,01	745,00



Imballo in astuccio di legno non contestabile in caso di rottura durante il trasporto

Tenere lontano da magneti o campi magnetici forti!!!



Becchi lunghi

Codice	Utile	Becchi	Letture	Prezzo €
001.944	500	150	0,01	408,00
001.945	500	200	0,01	431,50
001.946	600	150	0,01	469,00
001.947	600	200	0,01	627,00
001.949	1000	200	0,01	948,00

Calibri da officina digitali con becchi scorrevoli - Vite micrometrica - Cassa in PVC antiurto

Catalogo 1/44

ACCREDIA Certificati e RDT pagina 78



Codice	Utile	Becchi	Letture	Prezzo €
009.005	500	100	0,01	263,00
009.006	800	150	0,01	480,00
009.007	1000	150	0,01	625,00

Calibri da officina digitali alleggeriti - IP67 - Elettronica Sylvac con preset - Asta in carbonio

Catalogo 1/46

ACCREDIA Certificati e RDT pagina 78

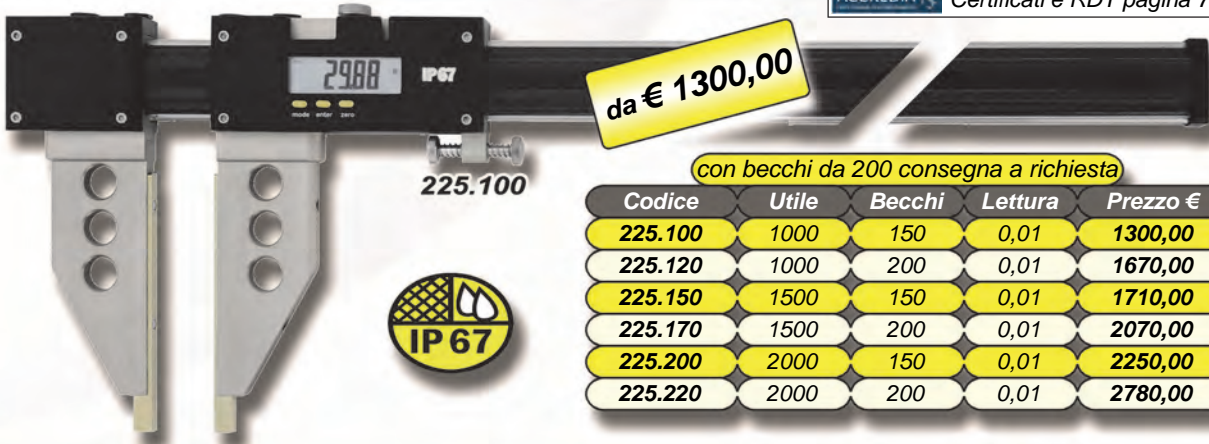

con becchi da 200 consegna a richiesta

Codice	Utile	Becchi	Letture	Prezzo €
225.100	1000	150	0,01	1300,00
225.120	1000	200	0,01	1670,00
225.150	1500	150	0,01	1710,00
225.170	1500	200	0,01	2070,00
225.200	2000	150	0,01	2250,00
225.220	2000	200	0,01	2780,00

Calibri da officina digitali - Protezione IP67 - Elettr. Sylvac con preset - Senza vite micrometrica

Catalogo 1/45

ACCREDIA Certificati e RDT pagina 78

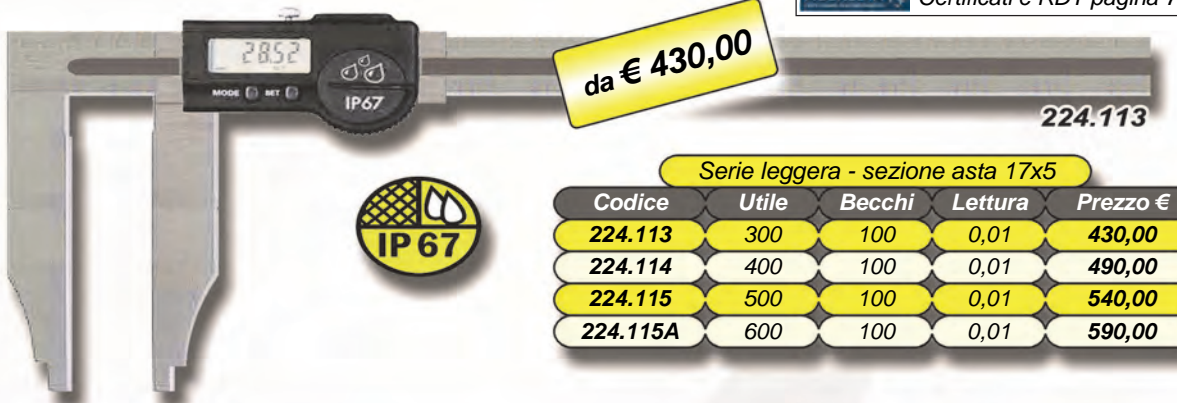

Serie leggera - sezione asta 17x5

Codice	Utile	Becchi	Letture	Prezzo €
224.113	300	100	0,01	430,00
224.114	400	100	0,01	490,00
224.115	500	100	0,01	540,00
224.115A	600	100	0,01	590,00

Calibri da officina digitali - Protezione IP67 - Elettronica Sylvac con preset

Catalogo 1/45

ACCREDIA Certificati e RDT pagina 78



Serie pesante - sezione asta 27x7

Codice	Utile	Becchi	Letture	Prezzo €
* 224.111	500	125	0,01	890,00
* 224.112	500	150	0,01	930,00
* 224.118	600	125	0,01	940,00
* 224.116	600	150	0,01	990,00
* 224.119	800	150	0,01	1290,00
224.120	1000	150	0,01	1600,00

Catalogo 1/46 Calibri digitali con becchi ridotti 1,5x8mm per gole esterne - Vite microm. - Elettr. "Preset"

ACCREDIA Certificati e RDT pagina 78

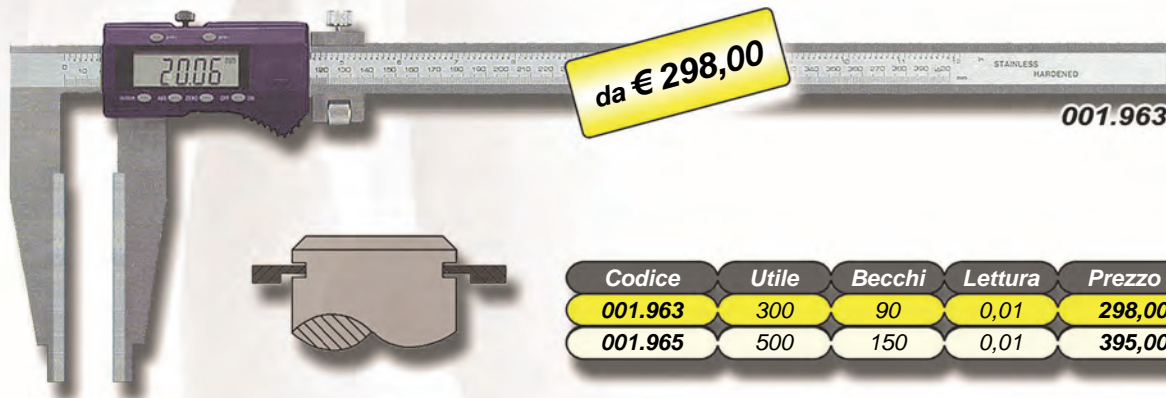

Codice	Utile	Becchi	Letture	Prezzo €
001.963	300	90	0,01	298,00
001.965	500	150	0,01	395,00

Catalogo 1/47 Calibri da officina digitali per gole int./est. - Becchi filettati M2,5 per puntalini comparatori

ACCREDIA Certificati e RDT pagina 78



Elettronica "Preset" per una lettura diretta

Codice	Utile	Becchi	Letture	Prezzo €
001.953	300	90	0,01	382,00
001.955	500	150	0,01	492,00

Catalogo 1/48 Calibri di profondità cinquantesimali - Acciaio cromato - Bloccaggio a vite superiore

ACCREDIA Certificati e RDT pagina 78



Codice	Utile	Ponte	Letture	Prezzo €
001.502	200	100	0,02	36,00
001.503	300	100	0,02	46,00
001.504	300	150	0,02	61,00
* 001.505	500	150	0,02	116,00

Catalogo 1/54 Calibri di profondità digitali - Bloccaggio a vite superiore - Protezione IP67

ACCREDIA Certificati e RDT pagina 78



Codice	Utile	Ponte	Letture	Prezzo €
215.620	200	100	0,01	163,00
215.630	300	150	0,01	202,00



Codice	Utile	Ponte	Lettura	Prezzo €
001.912	150	100	0,01	57,00
001.914	200	100	0,01	66,00
001.913	300	100	0,01	90,00
001.917	200	150	0,01	76,00
001.916	300	150	0,01	110,00
001.915	500	150	0,01	159,00



Codice	Utile	Ponte	Lettura	Prezzo €
001.931	150	100	0,01	73,00
001.934	200	100	0,01	89,00
001.933	300	100	0,01	124,00
001.937	200	150	0,01	101,00
001.936	300	150	0,01	146,00



Codice	Utile	Ponte	Lettura	Prezzo €
001.922	200	100	0,01	81,00
001.923	300	100	0,01	110,00
001.925	500	150	0,01	211,00



Codice	Utile	Ponte	Lettura	Prezzo €
001.926	200	100	0,01	103,00
001.927	300	100	0,01	112,00
001.928	500	100	0,01	209,00

Calibro di profondità ad orologio cinquantalesimale - Bloccaggio a vite superiore

Fuori catalogo



Codice	Utile	Ponte	Lettura	Prezzo €
001.562	150	100	0,02	21,00





Codice	Utile	Risc.	Arco	Prezzo €
002.891	0:25	---	28	25,00
002.892	25:50	25	38	28,00
002.893	50:75	50	49	30,00
002.894	75:100	75	60	32,00
002.895	100:125	100	73	37,00
002.896	125:150	125	85	42,00
002.897	150:175	150	104	48,00
002.898	175:200	175	117	55,00
002.899	200:225	200	130	63,00
002.900	225:250	225	142	67,00
002.901	250:275	250	152	75,00
002.902	275:300	275	167	80,00



Codice	Utile	Assortimenti	Prezzo €
002.903	0:100	4 micrometri	97,00
002.905	100:200	4 micrometri	188,00
002.908	200:300	4 micrometri	293,00



Codice	Utile	Assortimenti	Prezzo €
002.904	0:150	6 micrometri	160,00
002.909	150:300	6 micrometri	331,00

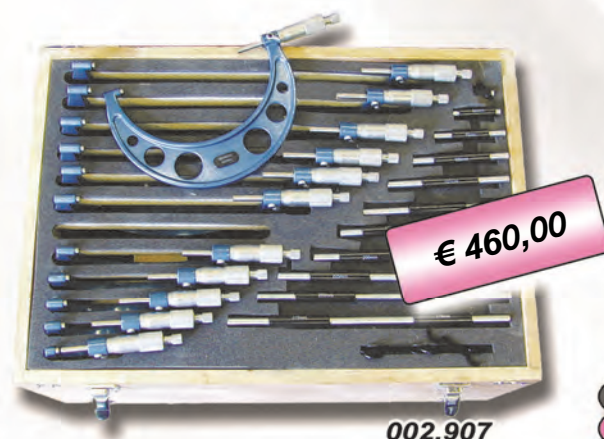

Codice	Utile	Assortimenti	Prezzo €
002.907	0:300	12 micrometri	460,00

ACCREDIA Certificati e RDT pagina 78



da € 22,00

002.071

Codice	Utile	Risc.	Arco	Prezzo €
002.071	0:25	---	24	22,00
002.072	25:50	25	32	25,00
002.073	50:75	50	45	32,00
002.074	75:100	75	57	35,00
002.075	100:125	100	70	41,00
002.076	125:150	125	82	48,00
002.077	150:175	150	95	56,00
002.080	175:200	175	107	60,00



da € 104,00

002.078

Codice	Utile	Assortimenti	Prezzo €
002.078	0:100	4 micrometri	104,00
002.079	0:150	6 micrometri	179,00

ACCREDIA Certificati e RDT pagina 78



002.251

da € 58,00

Codice	Utile	Risc.	Arco	Prezzo €
002.251	0:25	---	24	58,00
002.252	25:50	25	32	63,00
002.253	50:75	50	45	68,00
002.254	75:100	75	57	83,00
002.255	100:125	100	70	95,50
002.256	125:150	125	82	105,00
002.257	150:175	150	95	120,00
002.258	175:200	175	107	133,00

ACCREDIA Certificati e RDT pagina 78



002.501

da € 57,00

Lettura 0,001mm

Codice	Utile	Risc.	Arco	Prezzo €
002.501	0:25	---	24	57,00
002.502	25:50	25	32	62,00
002.503	50:75	50	45	68,00
002.504	75:100	75	57	78,00



Imballo in astuccio di legno non contestabile in caso di rottura durante il trasporto

da € 339,00

002.024D

Fino 1000mm corsa 25mm passo 0,5mm
1 incudine 100mm e 2 distanziatori 25 e 50



Oltre 1000mm corsa 50mm passo 1mm
1 incudine 200mm e 2 distanziatori 50 e 100



	Codice	Utile	Corsa	Tamb	Passo	Prezzo €
*	002.021D	300:400	25	18	0,5	339,00
*	002.022D	400:500	25	18	0,5	376,00
*	002.023D	500:600	25	18	0,5	436,00
*	002.024D	600:700	25	18	0,5	502,00
*	002.025D	700:800	25	18	0,5	582,00
*	002.026D	800:900	25	18	0,5	688,00
*	002.027D	900:1000	25	18	0,5	749,00



Imballo in astuccio di legno non contestabile in caso di rottura durante il trasporto

da € 259,00

002.024

Fino 1000mm corsa 25mm passo 0,5mm
1 incudine 100mm e 2 distanziatori 25 e 50



Oltre 1000mm corsa 50mm passo 1mm
1 incudine 200mm e 2 distanziatori 50 e 100



Codice	Utile	Corsa	Tamb	Passo	Prezzo €	Codice	Utile	Corsa	Tamb	Passo	Prezzo €
002.021	300:400	25	18	0,5	259,00	002.028	1000:1200	50	30	1	1089,00
002.022	400:500	25	18	0,5	289,00	002.029	1200:1400	50	30	1	1249,00
002.023	500:600	25	18	0,5	349,00	002.030	1400:1600	50	30	1	1358,00
002.024	600:700	25	18	0,5	399,00	002.031	1600:1800	50	30	1	1550,00
002.025	700:800	25	18	0,5	479,00	002.032	1800:2000	50	30	1	1650,00
002.026	800:900	25	18	0,5	580,00						
002.027	900:1000	25	18	0,5	647,00						

Disponibili fino a 3000mm con comparatore - Vedi pag.21

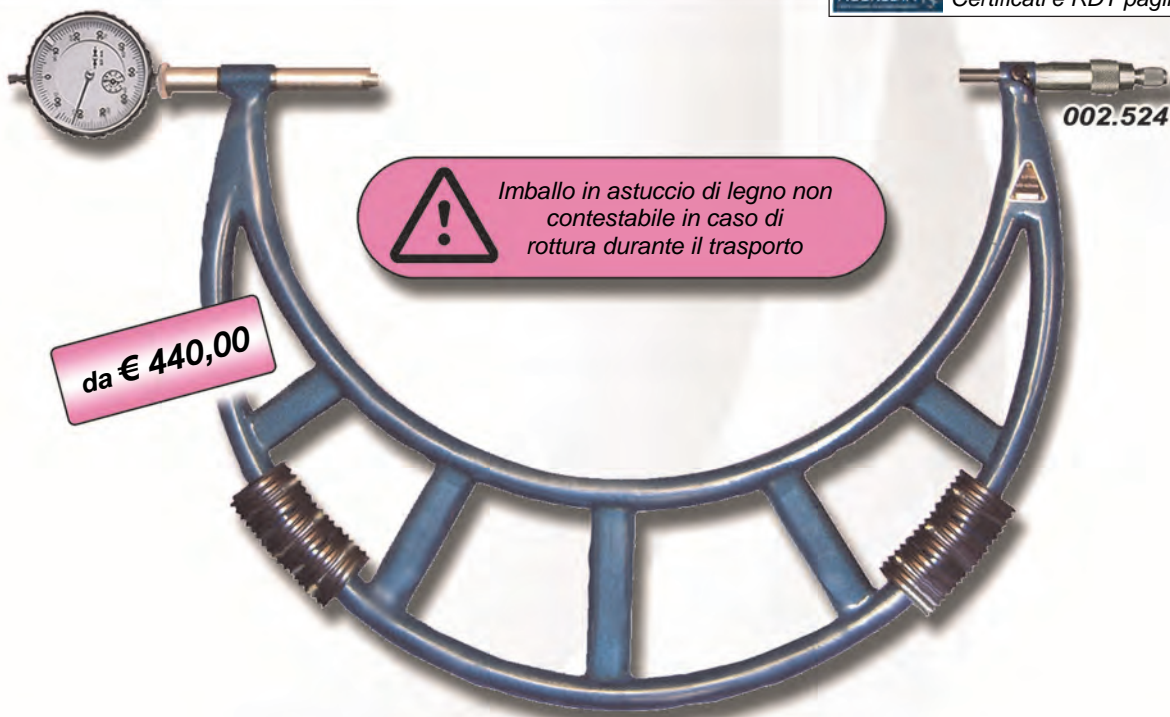

Codice	Utile	Tamb	Passo	Prezzo €	Codice	Utile	Tamb	Passo	Prezzo €
002.521	300:400	18	0,5	440,00	002.525	700:800	18	0,5	708,00
002.522	400:500	18	0,5	459,50	002.526	800:900	18	0,5	819,00
002.523	500:600	18	0,5	520,00	002.527	900:1000	18	0,5	929,00
002.524	600:700	18	0,5	611,00	002.530D	Perno per rimozione comparat.			27,00

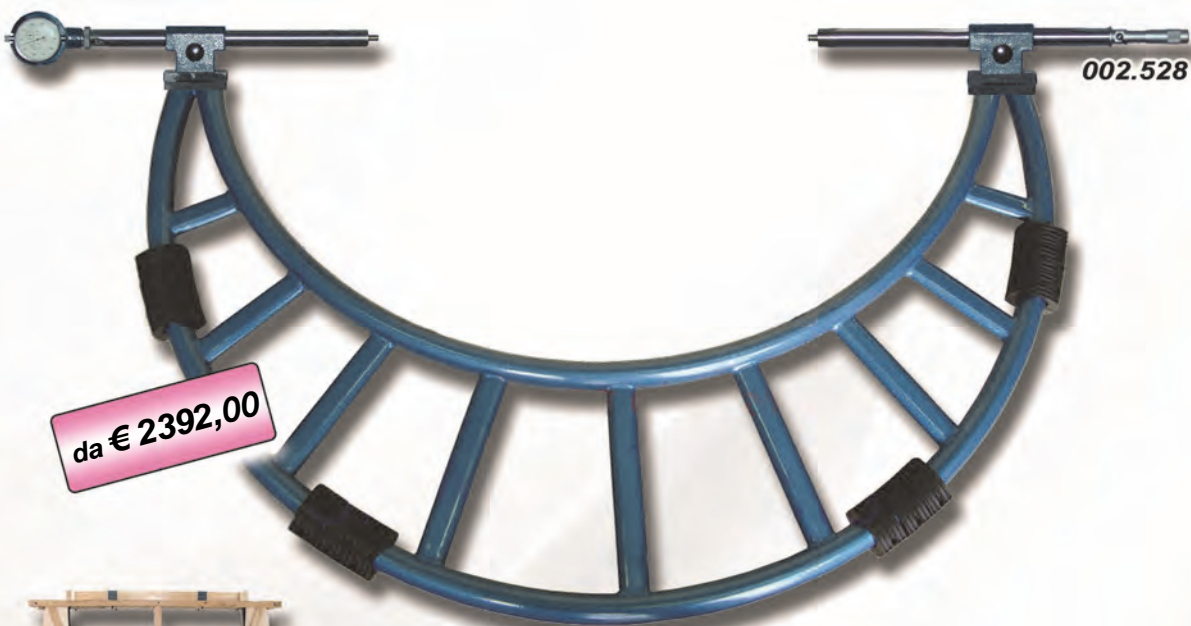

Codice 002.531 misura oltre 2500mm diventa trasporto eccezionale
Chiedere spesa di trasporto

Codice	Utile	Tamb	Passo	Prezzo €
002.528	1000:1500	18	0,5	2392,00
002.529	1500:2000	18	0,5	2631,00
002.530	2000:2500	18	0,5	3272,00
002.531	2500:3000	18	0,5	3486,00





002.116

Codice	Utile	Contatti	Arco	Prezzo €
002.116	0:25	0,75x6,5	37	169,00
002.117	25:50	0,75x6,5	50	172,00
002.118	50:75	0,75x6,5	62	182,00
002.119	75:100	0,75x6,5	70	208,00
002.120	100:125	0,75x6,5	82	237,00
002.121	125:150	0,75x6,5	95	248,00

Contatti ridotti

002.116A	0:25	0,4x3,5	37	176,00
----------	------	---------	----	--------



002.401

Codice	Utile	Piatt.	Arco	Prezzo €
002.401	0:25	Ø 20	24	148,00
002.402	25:50	Ø 20	32	165,00
002.403	50:75	Ø 20	45	177,00
002.404	75:100	Ø 20	57	198,00

Vite Ø 8mm passo 0,5mm
Senza bloccaggio
Disponibili fino a 200mm piattelli Ø 30mm

002.401A	0:25	Ø 30	24	188,50
002.402A	25:50	Ø 30	32	208,00
002.403A	50:75	Ø 30	45	218,00
002.404A	75:100	Ø 30	57	234,00



009.261

Codice	Utile	Piatt.	Arco	Prezzo €
009.261	0:25	Ø 20	26	179,00
009.262	25:50	Ø 20	38	200,00
009.263	50:75	Ø 20	50	217,00
009.264	75:100	Ø 20	62	230,00

Vite Ø8mm passo 0,5mm
Disponibili fino a 200mm piattelli Ø 30mm

009.261A	0:25	Ø 30	26	237,00
009.262A	25:50	Ø 30	38	261,00
009.263A	50:75	Ø 30	50	268,00
009.264A	75:100	Ø 30	62	292,00

ACCREDIA Certificati e RDT a richiesta

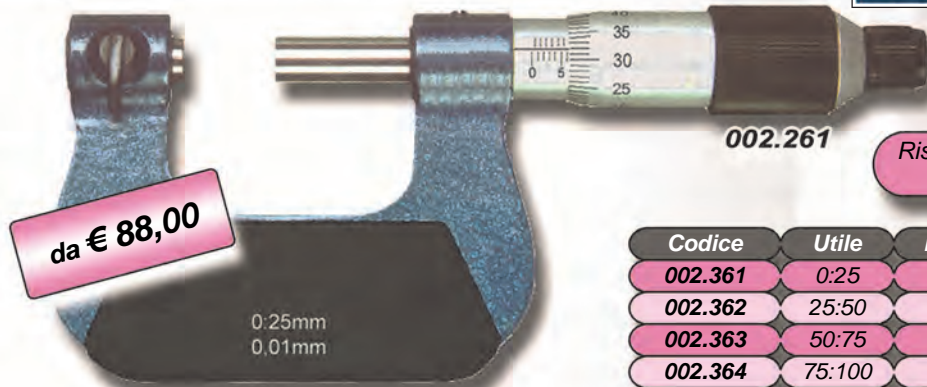

da € 88,00

0,25mm
0,01mm

002.261

Riscontri e capruggini Ø 5x15mm
Non compresi

Codice	Utile	Risc.	Arco	Prezzo €
002.361	0:25	---	26	88,00
002.362	25:50	---	38	100,00
002.363	50:75	---	50	112,00
002.364	75:100	---	62	126,00
002.365	100:125	---	70	153,00
002.366	125:150	---	82	159,00
002.367	150:175	---	92	190,00
002.368	175:200	---	107	209,00

Capruggini 55°

Codice	Passo Ww	Filetto	Prezzo €
002.399A	60-48	55°	19,00
002.399B	48-40	55°	19,00
002.399C	40-32	55°	19,00
002.399D	32-24	55°	19,00
002.399E	24-18	55°	19,00
002.399F	18-14	55°	19,00
002.399G	14-10	55°	19,00
002.399H	10-7	55°	19,00
002.399I	7-4,5	55°	19,00
002.399K	4,5-3,5	55°	19,00
002.399	10 coppie passo Ww 60-3,5		178,00

Capruggini 60°

Codice	Passo M	Filetto	Prezzo €
002.398A	0,4-0,5	60°	20,00
002.398B	0,6-0,9	60°	20,00
002.398C	1,0-1,75	60°	20,00
002.398D	2,0-3,0	60°	20,00
002.398E	3,5-5,0	60°	20,00
002.398F	5,5-7,0	60°	20,00
002.398	6 coppie passo M 0,4-7,0		97,00

Riscontri 55°

Codice	Lunghezza	Gradi	Prezzo €
002.390	25	55°	33,00
002.391	50	55°	37,00
002.392	75	55°	41,00
002.393	100	55°	49,00
002.394	125	55°	56,00
002.395	150	55°	66,00
002.396	175	55°	73,00

Riscontri 60°

Codice	Lunghezza	Gradi	Prezzo €
002.380	25	60°	33,00
002.381	50	60°	37,00
002.382	75	60°	41,00
002.383	100	60°	49,00
002.384	125	60°	56,00
002.385	150	60°	66,00
002.386	175	60°	73,00

Terne di fili calibrati per la misurazione di filetti

800.809



€ 140,00 cad

Codice	Codice	Ø filo	Filetto M	Passo	Filetto Ww	Unc/Unf	Trapez
Ø 6,5	Ø 8	d	nominal	60°	55°	60°	30°
800.801	800.801A	0,170	M 1-1,2-1,4	0,25-0,30	---	---	---
800.802	800.802A	0,220	M 1,6-1,8	0,35	---	72	---
800.803	800.803A	0,250	M 2	0,40	60	64	---
800.804	800.804A	0,290	M 2-2,5-3	0,45-0,50	---	56	---
800.805	800.805A	0,335	M 3,5	0,60	48-40	48-44	---
800.806	800.806A	0,455	M 4-4,5-5	0,70-0,75-0,80	---	---	---
800.800	800.800A	0,530	M 5,5	0,90	32-28	32-28	---
800.807	800.807A	0,620	M 6-7	1,00	26-24	24	---
800.808	800.808A	0,725	M 8-9	1,25	22-20-19	20	---
800.809	800.809A	0,895	M 10-11	1,50	18-16	18-16	---
800.810	800.810A	1,100	M 12	1,75	14	14-13	2
800.811	800.811A	1,350	M 14-16	2,00	12-11	12-11	---
800.812	800.812A	1,650	M 18-20-22	2,50	10-9	10-9	3
800.813	800.813A	2,050	M 24-27-30-33	3,00-3,50	8-7	8-7	4
800.814	800.814A	2,550	M 36-39-42-45	4,00-4,50	6	6	5
800.815	800.815A	3,200	M 48-52-56-60	5,00-5,50	5-4½	5-4½	6

001.103

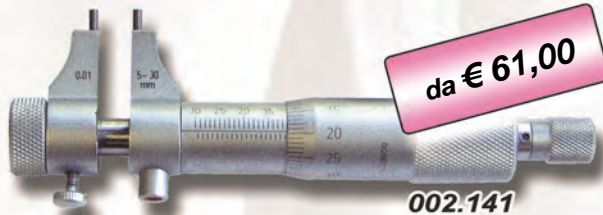

da € 61,00

002.141



002.142

Codice	Utile	Anello	Prezzo €
002.141	5:30	Ø 5	61,00
002.142	25:50	Ø 25	70,50
002.143	50:75	---	85,50
002.144	75:100	---	96,50
002.155	100:125	---	114,50
002.156	125:150	---	129,00



da € 313,00

002.149



002.149A

Codice	Utile	Anelli e Risc.	Prezzo €
002.149	5:100	Ø 5+25	313,00
002.149A	5:100	Ø 5+25+75	365,00



€ 183,00

002.135

Codice	Utile	Ø aste	Prezzo €
002.135	50:600	Ø 15,5	183,00
Aste 13 - 25 - 50 - 100 - 150 - 200			

Aste di ricambio/supplemento

Codice	Lunghezza	Ø asta	Prezzo €
002.130D	100	15,5	48,50
002.130F	200	15,5	55,00
002.130G	300	15,5	86,00



da € 363,00

002.138

Vite micrometrica passo 0,5 corsa 13mm
Forniti in cofanetti di alluminio
Aste da 13 a 300mm

Codice	Utile	Ø aste	Prezzo €
002.138	50:1000	15,5	363,00
Aste 13 - 25 - 50 - 2x100 - 150 - 200 - 300			
002.138G	50:1500	15,5	603,00
Aste 13 - 25 - 50 - 2x100 - 150 - 2x200 - 2x300			

ACCREDIA Certificati e RDT pagina 79



da € 168,50

Codice	Utile	Base	Prezzo €
009.986	0:100	100x16	168,50
009.987	0:200	100x16	274,50

Micrometri centesimali di profondità - Aste intercambiabili - Bloccaggio a vite - Passo 0,5mm

ACCREDIA Certificati e RDT pagina 79

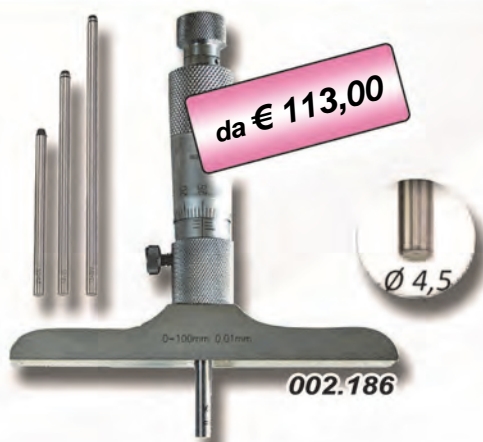

da € 113,00

Codice	Utile	Base	Prezzo €
002.186	0:100	100x16	113,00
002.187	0:200	100x16	168,00
002.188	0:300	100x16	199,00

Testine micrometriche centesimali e millesimali - Corsa 25mm - Codolo Ø12mm

ACCREDIA Certificati e RDT pagina 79



da € 23,50

Codice	Utile	Ø	Rotaz.	Let.	Prezzo €
002.241	0:25	6,5	Si	0,01	23,50
002.242	0:25	8	Si	0,01	25,50
002.271	0:25	8	No	0,01	36,50
002.272	0:25	8	No	0,002	38,50
002.275	0:25	6,5	Si	0,001	36,00

Senza parallasse

Portamicrometri inclinabili - 002.201 acciaio - 002.203 fusione leggera



da € 18,00

Codice	Micrometri	Apertura	Prezzo €
002.201	<300	14	36,00
002.203	<200	21	18,00



Codice	Utile	Anello	Prezzo €
002.301P	6:8	Ø 8	256,00
002.302P	8:10	Ø 8	256,00
002.303P	10:12	Ø 10	256,00
002.304P	12:16	Ø 12	189,00
002.305P	16:20	Ø 16	189,00
002.306P	20:25	Ø 20	238,00
002.307P	25:30	Ø 25	238,00
002.308P	30:40	Ø 30	280,00
002.309P	40:50	Ø 40	319,00
002.310P	50:63	Ø 50	319,00
002.311P	63:75	Ø 62	350,00
002.312P	75:88	Ø 87	359,00
002.313P	87:100	Ø 87	379,00
002.314P	100:125	---	489,00
002.315P	125:150	---	489,00

Assortimenti inclusi anelli e prolungh

Codice	Utile	Anelli	Prezzo €
002.325P	6:12	Ø 8+10	657,00
002.326P	12:20	Ø 16	335,00
002.327P	20:50	Ø 25+40	775,00
002.328P	50:100	Ø 62+87	1145,00



Utile	Analogo	Digitale	Pistola
Inizio cod.	XT	XTD	XTH
Contatti temprati - Incluso anello			
6:8	889.516	987.716	988.716
8:10	889.517	987.717	988.717
10:12,5	889.518	987.718	988.718
Contatti in metallo duro - Incluso anello - Fondo gola			
12,5:16	889.519	987.719	988.719
16:20	889.520	987.720	988.720
20:25	889.521	987.721	988.721
25:35	889.522	987.722	988.722
35:50	889.523	987.723	988.723
50:65	889.524	987.724	988.724
65:80	889.525	987.725	988.725
80:100	889.526	987.726	988.726
100:125	889.527	987.727	988.727
125:150	889.528	987.728	988.728
150:175	889.529	987.729	988.729
175:200	889.530	987.730	988.730
Assortimenti - Incluso anello/i			
6:10	889.553	987.753	988.753
10:20	889.554	987.754	988.754
20:50	889.555	987.755	988.755
50:100	889.556	987.756	988.756
100:150	889.557	987.757	988.757
150:200	889.558	987.758	988.758
6:20	---	---	988.751
20:100	---	---	988.752
100:200	---	987.759	988.759

ACCREDIA Certificati e RDT pagina 78



009.521

Codice	Utile	Risc.	Lettura	Prezzo €
009.521	0:25	---	0,001	103,00
009.522	25:50	25	0,001	122,50
009.523	50:75	50	0,001	164,00
009.524	75:100	75	0,001	194,00
009.525	100:125	100	0,001	204,50
009.526	125:150	125	0,001	215,50
009.527	150:175	150	0,001	242,00
009.528	175:200	175	0,001	282,50

Disponibili fino a 275:300



009.541

Corsa 1 giro 2 mm
Frizione a cricchetto in PVC

Codice	Utile	Risc.	Lettura	Prezzo €
009.541	0:25	---	0,001	128,00
009.542	25:50	25	0,001	160,00

Disponibili fino a 175:200

ACCREDIA Certificati e RDT pagina 78



009.235

Codice	Utile	Risc.	Arco	Prezzo €
009.235	0:35	---	38	105,00
009.236	35:70	50	51	130,00
009.237	65:100	75	60	150,00

ACCREDIA Certificati e RDT pagina 78



009.505

Disponibili fino a 75:100

Codice	Utile	Risc.	Lettura	Prezzo €
009.505	0:25	---	0,001	66,00
009.506	25:50	25	0,001	82,00



da € 98,00

009.211

Disponibili fino a 275:300

Codice	Utile	Risc.	Arco	Prezzo €
009.211	0:25	- - -	26	98,00
009.212	25:50	25	32	114,50
009.213	50:75	50	44	136,50
009.214	75:100	75	57	158,00
009.215	100:125	100	70	185,00
009.216	125:150	125	82	210,00
009.217	150:175	150	94	232,00
009.218	175:200	175	107	255,00



da € 215,00

009.772

Stelo rotante



002.951A-B-C-D-E-F-G-H-I-J



002.939

Codice	Utile	Arco	Letture	Prezzo €
009.772	0:25(50)	37	0,001	215,00
009.774	50:75(100)	62	0,001	250,00
002.951A/J	1 coppia sfere disp. da Ø1 a Ø6			57,50
002.939	Set 7pz inserti vari			128,00



Stelo non rotante

da € 210,00

009.791

Inserti per filetti e riscontri
consultare Promo corrente a pagina 23

Codice	Utile	Arco	Letture	Prezzo €
009.791	0:25	26	0,001	210,00
009.792	25:50	38	0,001	219,00
009.793	50:75	50	0,001	245,00
009.794	75:100	62	0,001	269,50
009.795	100:125	70	0,001	294,00
009.796	125:150	82	0,001	322,00
009.797	150:175	92	0,001	337,00
009.798	175:200	107	0,001	367,50



da € 56,00

005.593

005.599



005.593



005.598



€ 74,50

005.598

Codice	Lunghezza	Letture	Prezzo €
Base piana in acciaio rettificato senza magneti			
005.599	150	0,05°	56,00
Base prismatica in acciaio con 12 magneti			
005.593	150	0,05°	85,00
Base semiprismatica in alluminio con 2 magneti			
005.598	150	0,05°	74,50



da € 177,00

005.542

Codice	Utile	Precisione	Prezzo €
005.541	150x150	0,02	189,00
005.542	200x200	0,02	197,50
005.545	150x150	0,05	177,00
005.546	200x200	0,05	190,00



da € 108,00

005.442

Codice	Utile	Precisione	Prezzo €
005.441	150	0,02	120,00
005.442	200	0,02	137,00
005.444	300	0,02	177,00
005.445	150	0,05	108,00
005.446	200	0,05	129,00



€ 75,50

003.068

Codice	Utile	Aste	Prezzo €
003.068	4x90°	150-200-300	75,50

Con orologio 5'

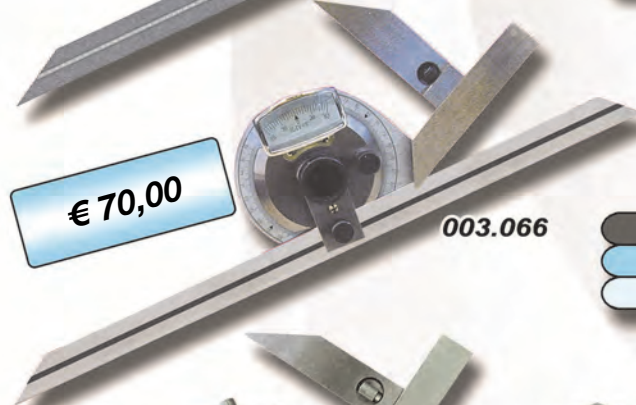

€ 70,00

003.066

Codice	Utile	Aste	Prezzo €
003.066	4x90°	150-200-300	70,00

Nonio 5' con lente d'ingrandimento



€ 310,00

003.995

Codice	Utile	Aste	Prezzo €
003.995	90°-180°-360°	150-200-300	310,00
003.994	Asta supplementare da 500		31,00

Digitale con doppia lettura 1' o 0,01°



da € 66,50

003.995



Codice	Utile	Angoli	Prezzo €
003.590	300	45°-135°	66,50
003.591	600	45°-135°	84,50

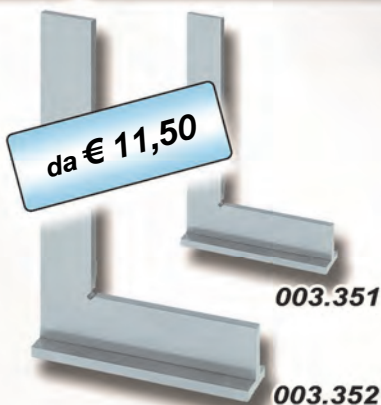

da € 11,50

003.351

003.352

Codice	Altezza	Base	Prezzo €
003.351	100	70	11,50
003.352	150	100	14,00
003.353	200	130	18,00
003.354	250	160	21,00
003.355	300	180	26,00
003.356	400	210	34,50
003.357	500	260	38,50

Goniometri semplici - Finitura cromata - Incisione a laser - Lettura 1°

Catalogo 3/9

ACCREDIA Certificati e RDT pagina 83

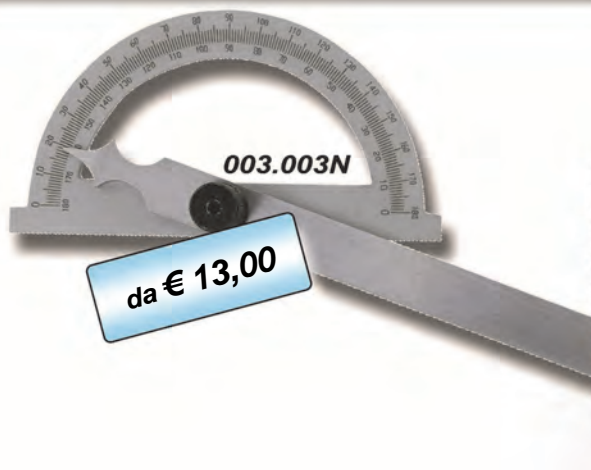

Codice	Arco Ø	Asta	Prezzo €
003.001N	80	120	13,00
003.002N	120	150	18,50
003.003N	150	200	23,50
003.004N	200	300	32,00
003.005N	250	500	59,00
003.006N	300	600	82,50

Disponibili fino a 400x1000mm

Goniometri con asta scorrevole - Finitura cromata - Incisione a laser - Lettura 1°

Catalogo 3/9

ACCREDIA Certificati e RDT pagina 83



Codice	Arco Ø	Asta	Prezzo €
003.011N	100	150	27,00
003.012N	150	300	33,00
003.013N	200	400	38,50
003.014N	250	500	55,50
003.015N	300	600	67,00

Goniometri semplici digitali - Lettura 0,05° - Utile 0-180°

Catalogo 3/11

ACCREDIA Certificati e RDT pagina 83

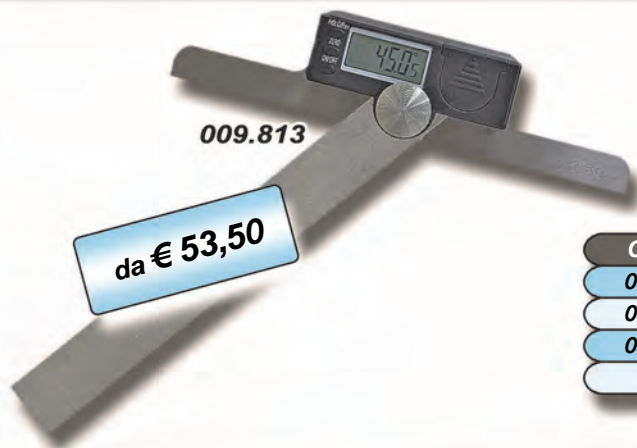

Codice	Base	Asta	Prezzo €
009.811	120	150	53,50
009.812	150	200	61,00
009.813	200	300	74,00

Disponibili fino a 400x1000mm

Squadre digitali - Lettura 0,05° - Aste graduate incise a laser - Utile 0-180°

Catalogo 3/11

ACCREDIA Certificati e RDT pagina 83

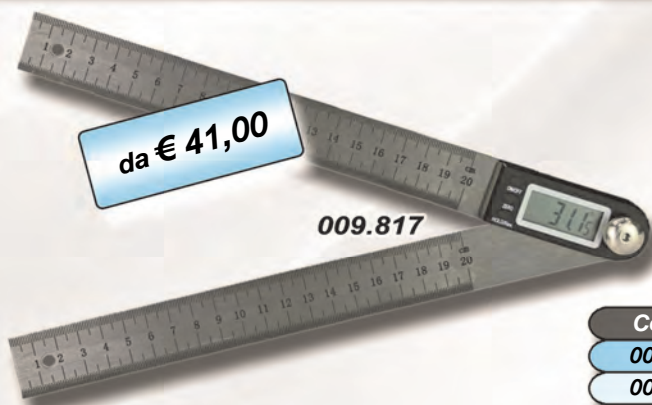

Codice	Base	Asta	Prezzo €
009.817	200	200	41,00
009.818	300	300	46,00



004.006

€ 24,50

Codice	Utile	Ghiera	Lettura	Prezzo €
004.006	0:5	Ø40	0,01	24,50



004.010

004.014

da € 14,00

Codice	Utile	Ghiera	Lettura	Prezzo €
004.010	0:10	Ø58	0,01	14,00

Codice	Utile	Ghiera	Lettura	Prezzo €
004.014	0:10	Ø58	0,01	21,00

Dispositivo antiurto con quadrante giallo



004.037

da € 50,00

Eco

Codice	Utile	Ghiera	Lettura	Prezzo €
004.037	0:30	Ø58	0,01	71,00
* 004.037E	0:30	Ø58	0,01	50,00
004.039	0:50	Ø58	0,01	99,50
004.038	0:80	Ø58	0,01	180,00

*



004.041

da € 22,00

Codice	Utile	Ghiera	Lettura	Prezzo €
004.041	0:10	Ø58	0,1	22,00
004.043	0:30	Ø58	0,1	47,50

Compartatori centesimali - Ghiera Ø40 o 58 mm - Lancette concentriche - Cassa metallica

Catalogo 4A/7

ACCREDIA Certificati e RDT pagina 82



702.045

702.058

da € 27,00

Codice	Utile	Ghiera	Lettura	Prezzo €
702.045	0:10	Ø40	0,01	28,00
702.058	0:10	Ø58	0,01	27,00

Comparatori originali Käfer centesimali - Serie specilai promozionali

Catalogo 4A/10

ACCREDIA Certificati e RDT pagina 82



701.200

701.100

da € 40,00



Codice	Utile	Ghiera	Lettura	Prezzo €
701.200	0:10	Ø58	0,1-Lin	40,00

Codice	Utile	Ghiera	Lettura	Prezzo €
701.100	0:10	Ø58	0,1-Lin	55,00

Ghiera metallica, cappuccio antipolvere e puntalino in rubino

Compartatori centesimali - Antispruzzo con ghiera avvitata - Soffietto copristelo

Catalogo 4A/13

ACCREDIA Certificati e RDT pagina 82



004.708

da € 41,00



Antispruzzo

Codice	Utile	Ghiera	Lettura	Prezzo €
004.708	0:10	Ø61,5	0,01	52,00

Codice	Utile	Ghiera	Lettura	Prezzo €
* 004.708E	0:10	Ø61,5	0,01	41,00

Comparatori millesimali - Corsa 1mm o 5mm - Quadrante Ø58mm

Catalogo 4A/16

ACCREDIA Certificati e RDT pagina 82



004.051

004.053

da € 56,00



Codice	Utile	Tratti	Lettura	Prezzo €
004.051	0:1	100	0,001	63,00

Codice	Utile	Tratti	Lettura	Prezzo €
* 004.051E	0:1	100	0,001	56,00

Codice	Utile	Tratti	Lettura	Prezzo €
004.053	0:5	200	0,001	69,50

Catalogo 4A/21

Compartatori digitali centesimali - 0,01 mm/inch (004.901 con funzione memo)

ACCREDIA Certificati e RDT pagina 82



da € 47,00

Codice	Utile	Letture	Precis.	Prezzo €
004.945	0:12	0,01	±0,04	47,00

Codice	Utile	Letture	Precis.	Prezzo €
004.901	0:12	0,01	±0,02	56,50

Catalogo 4A/20

Comparatori digitali 0,01 o 0,001 - Funzioni ABS-Inc-Tol (*) oppure Preset ± ()**

ACCREDIA Certificati e RDT pagina 82



da € 75,00

Codice	Utile	Letture	Precis.	Prezzo €
004.948*	0:12	0,01	±0,02	75,00
004.949*	0:25	0,01	±0,03	110,00
004.950*	0:50	0,01	±0,04	165,00
004.975*	0:12	0,001	±0,015	88,50
004.981*	0:12	0,001	±0,009	96,00
004.986*	0:12	0,001	±0,005	138,00

Codice	Utile	Letture	Precis.	Prezzo €
004.968**	0:12	0,01	±0,02	76,00
004.980**	0:12	0,001	±0,009	96,00
004.985**	0:12	0,001	±0,005	138,00

Catalogo 4A/21

Compartatori digitali centesimali o millesimali - Funzioni Preset ±

ACCREDIA Certificati e RDT pagina 82



da € 99,50



Uscita dati

Codice	Utile	Letture	Precis.	Prezzo €
004.951	0:12	0,01	±0,02	99,50
004.952	0:25	0,01	±0,03	133,00
004.953	0:50	0,01	±0,04	207,00

Codice	Utile	Letture	Precis.	Prezzo €
004.959	0:12	0,001	±0,002	142,00

Fuori catalogo

Misuratori rapidi decimali - Contatti sfere Ø2mm - Lettura 0,1mm

ACCREDIA Certificati e RDT pagina 82



€ 35,00

Codice	Utile	Letture	Bracci	Prezzo €
004.631	0:10	0,1	36mm	35,00

Alesametri semplici - Finitura cromata - Comparatore 1/100° compreso - (004.556 set digitale) Catalogo 4B/18

ACCREDIA Certificati e RDT a richiesta

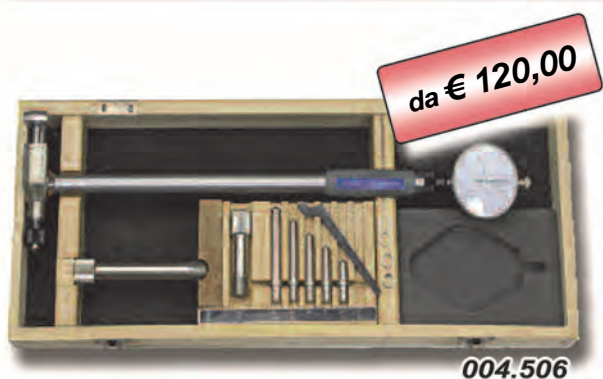

da € 120,00

004.506

Set alesametri con comparatore digitale

Codice	Utile	Profondità	Prezzo €
004.501	6:10	45	120,00
004.502	10:18	100	120,00
004.503	18:35	150	120,00
004.504	35:50	150	120,00
004.514	35:70	150	148,50
004.506	50:160	150	120,00
004.526	50:160	500	215,00
004.507	160:250	400	135,00
004.508	250:450	400	146,50
Set 004.555	18:160	150	306,00
Set 004.556	18:160	150	383,00

Alesametri nuova produzione nazionale - Comparatori esclusi Catalogo 4B/16

ACCREDIA Certificati e RDT a richiesta



da € 200,00

520.105L

Codice	Utile	Profondità	Prezzo €
520.101	15:35	175	200,00
520.102	30:100	250	209,00
520.102L	30:125	250	226,00
520.103	50:160	250	242,00
520.104	50:210	380	270,00
520.104L	50:265	380	297,00
520.105	100:300	350	413,00
520.105L	100:500	350	480,00
520.106	100:500	650	598,00
520.107	190:1000	650	996,00

Alesametri TOP - Contatti in metallo duro - Comparatori esclusi Catalogo 4B/18

ACCREDIA Certificati e RDT a richiesta



da € 305,50

530.205

Errore massimo $\pm 2 \mu\text{m}$ - Ripetibilità $1 \mu\text{m}$
A rich. con asta corta ed esec. fori ciechi



Puntale r8 in widia raggiato antigraffio
Impugnatura con isolamento termico

Codice	Utile	Profondità	Prezzo €
530.201	15:35	175	305,50
530.202	30:100	250	305,50
530.203	50:160	250	324,50
530.204	50:210	380	385,00
530.205	100:300	350	585,50
530.206	100:500	650	832,50
530.207	190:1000	650	1468,00

Alesametri Schwenk - Serie Rabito - Contatti in acciaio temprato - Comparatori esclusi Catalogo 4B/19

ACCREDIA Certificati e RDT a richiesta



da € 260,00

530.603

Errore massimo 3 micron



Codice	Utile	Profondità	Prezzo €
531.601	18:35	110	268,00
531.602	35:60	138	260,00
531.603	50:150	177	302,00
531.604	150:300	177	537,00

Set 531.610 18:150 Vedere sopra 525,00



da € 39,00



Codice	Utile	Quadr.	Puntale	Prezzo €
004.104	0:0,8	Ø38	L 16	51,50
004.105	0:0,8	Ø32	L 16	51,50
* 004.104E	0:0,8	Ø40	L 16	42,00
* 004.105E	0:0,8	Ø32	L 16	39,00



da € 68,00



Codice	Utile	Quadr.	Puntale	Prezzo €
004.118	0:0,8	Ø38	L 30	93,50
004.119	0:0,8	Ø32	L 30	89,00
* 004.118E	0:0,8	Ø40	L 30	68,00



da € 45,00



Codice	Utile	Quadr.	Puntale	Prezzo €
004.111	0:0,8	Ø32	L 12	58,00
* 004.111E	0:0,8	Ø32	L 12	45,00



€ 71,00

Codice	Utile	Quadr.	Puntale	Prezzo €
004.209	0:0,2	Ø32	L 14	71,00

ACCREDIA Certificati e RDT pagina 82



Codice	Utile	Quadr.	Puntale	Prezzo €
714.101	0:0,8	Ø32	L 12,8	113,50
714.102	0:0,8	Ø40	L 12,8	117,00

Codice	Utile	Quadr.	Puntale	Prezzo €
714.107	0:0,5	Ø32	L 35,7	161,50
714.108	0:0,5	Ø40	L 35,7	164,50

Tastatori centesimali - Forma A - Quadrante inclinato 30°

Fuori catalogo

ACCREDIA Certificati e RDT pagina 82



Quadrante inclinato 30° per lettura facile

Codice	Utile	Quadr.	Puntale	Prezzo €
* 004.115	0:0,8	Ø30	L 16,5	59,00
* 004.114	0:0,8	Ø38	L 16,5	61,00

Tastatori centesimali corsa lunga con contagiri - Forma A - Quadrante inclinato 30°

Fuori catalogo

ACCREDIA Certificati e RDT pagina 82



Attacco Ø4 girevole 160°

Puntalino girevole 150°

Quadrante inclinato 30° per lettura facile

Codice	Utile	Quadr.	Puntale	Prezzo €
* 004.125	0:1,6	Ø30	L 16,5	90,00
* 004.124	0:1,6	Ø38	L 16,5	92,00

Tastatori bi-millesimali Käfer - Forma A - Accessori per tastatori

Catalogo 4A/27

ACCREDIA Certificati e RDT pagina 82



Codice	Utile	Quadr.	Puntale	Prezzo €
714.201	0:0,2	Ø32	L 12,8	138,00
714.202	0:0,2	Ø40	L 12,8	141,50

714.998	Archetto Ø8 - fori Ø4 e Ø8mm	20,00
---------	------------------------------	-------



Codice	Montante	Traversa	Kg/Fil	Prezzo €
004.261	Ø12/175	Ø10/150	60/M8	22,00
004.251E	Ø12/175	Ø10/150	60/M8	18,00
004.261-8	Ø12/175	Ø10/150	80/M8	23,50
004.377	Ø16/230	Ø14/200	100/M8	36,00
004.252E	Ø16/230	Ø14/200	100/M8	31,00

Senza vite micrometrica

Codice	Montante	Traversa	Kg/Fil	Prezzo €
004.263	Ø12/175	Ø10/150	60/M8	24,00
* 004.253E	Ø12/175	Ø10/150	60/M8	18,00
004.263-8	Ø12/175	Ø10/150	80/M8	25,50
* 004.257E	Ø12/175	Ø10/150	80/M8	20,00
004.276	Ø16/230	Ø14/200	100/M8	39,00
* 004.254E	Ø16/230	Ø14/200	100/M8	35,50

Con vite micrometrica

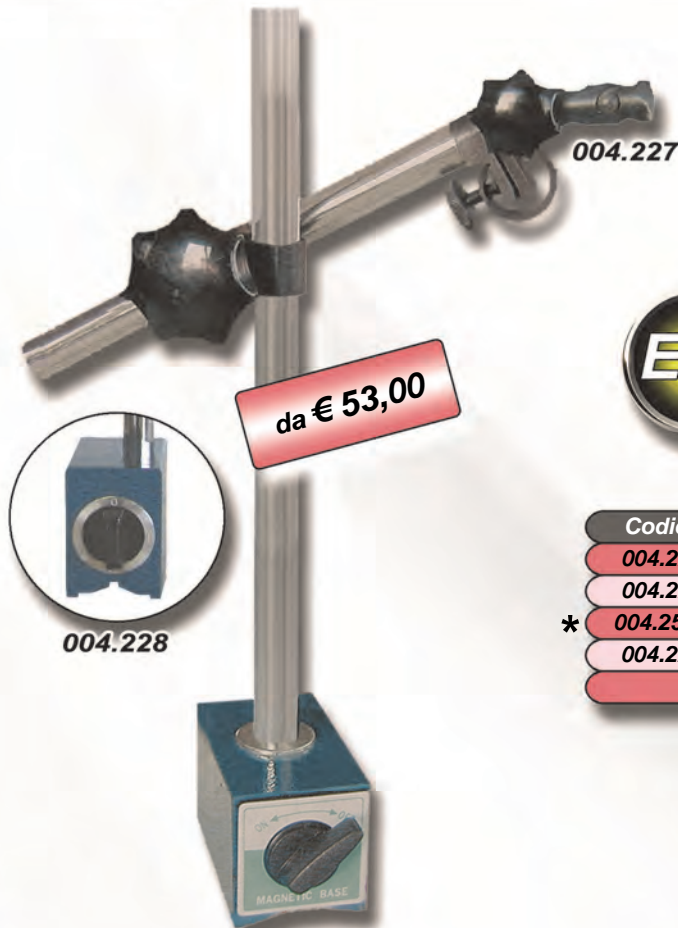

Codice	Montante	Traversa	Kg/Fil	Prezzo €
004.226	Ø16/210	Ø16/210	60/M10	56,50
004.227	Ø20/360	Ø16/360	120/M12	92,50
* 004.255E	Ø20/360	Ø16/360	120/M12	53,00
004.228	Ø20/420	Ø16/390	80/M12	104,50

Con vite micrometrica



Codice	H con magn.	Magnete	Prezzo €
* 004.221	145+35	30kg M5	35,00
* 004.222	290+55	60Kg M8	42,00
* 004.223	365+55	60kg M8	58,00

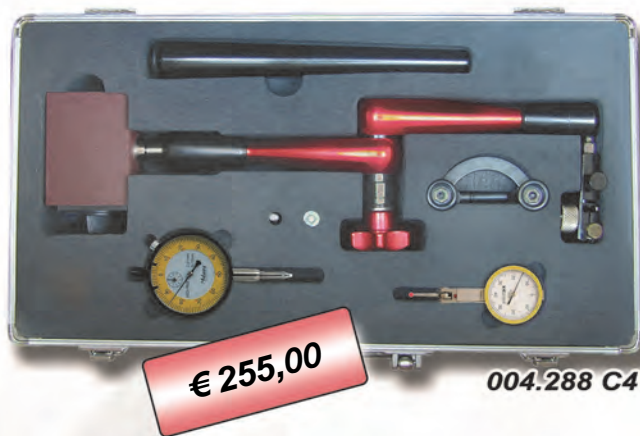

Codice	H con magn.	Magnete	Prezzo €
004.286	270+55	80kg M8	119,50
004.286 confezione scatola in cartone			
004.288	380+55	100kg M8	169,50
004.288 confezione cofanetto in alluminio			
004.288C4	Comparatore Ø58 - Tastatore Ø40 Archetto Ø4+Ø8 - Prolunga 200		255,00
Codice	H con magn.	Magnete	Prezzo €
004.215	350+55	60kg M8	53,00
* 004.258E	350+55	60kg M8	41,50
004.215-8	350+55	80kg M8	54,50



Codice	Raggio	Magnete	Prezzo €
004.295	200	80kg M8	169,00
Equivalente codice catalogo 428.601			

Codice	Raggio	Magnete	Prezzo €
004.305	280	80kg M8	209,00
Equivalente codice catalogo 430.601			

Codice	Raggio	Magnete	Prezzo €
004.311	400	100kg M8	233,00
Equivalente codice catalogo 429.601			



Codice	Raggio	Magnete	Prezzo €
004.245	200	80kg M8	196,00
Equivalente codice catalogo 424.601			

Codice	Raggio	Magnete	Prezzo €
004.256	280	100kg M8	264,00
Equivalente codice catalogo 420.602			



ACCREDIA Certificati e RDT pagina 82



Kroeplin
Längenmesstechnik



Codice	Utile	Tipo	Bracci	Prezzo €
440.912	5:15	H 105	35	a richiesta
440.941	10:30	H 210	85	a richiesta
440.943	30:50	H 230	85	a richiesta
440.944	40:60	H 240	85	a richiesta
440.945	50:70	H 250	85	a richiesta

Misuratori rapidi centesim. - Digit. per interni Kroeplin - Serie L - Sfera Ø1 - 943.002 millesim.

ACCREDIA Certificati e RDT pagina 82



Kroeplin
Längenmesstechnik



Codice	Utile	Tipo	Bracci	Prezzo €
943.002	5:20	G 005	44	a richiesta
941.911	2,5:12,5	L 102	12	a richiesta
941.912	5:15	L 105	35	a richiesta
941.941	10:30	L 210	85	a richiesta
941.942	20:40	L 220	85	a richiesta
941.943	30:50	L 230	85	a richiesta
941.955	16:55	G 415	188	a richiesta

Misuratori rapidi centesimali - Digitali per esterni Kroeplin - Serie K - IP67

ACCREDIA Certificati e RDT pagina 82



Kroeplin
Längenmesstechnik



Codice	Utile	Tipo	Bracci	Prezzo €
961.953	0:20	K 220	85	a richiesta
961.955	0:30	K 330	116	a richiesta
961.957	0:50	C 450	167	a richiesta

Misuratori rapidi decimali - Analogici per esterni Kroeplin - Serie Pocotest

ACCREDIA Certificati e RDT pagina 82



Kroeplin
Längenmesstechnik

Codice	Utile	Tipo	Bracci	Prezzo €
445.631	0:10	Poco 2K	36	a richiesta



da € 125,00

510.047



Supplementi certificati di taratura D1 (1 punto)

Codice	Prezzi	Comp	Gradi	Prezzo €
C005.032	32pz	A	0-1-2	216,00
C005.047	47pz	B-C	0-1-2	318,00
C005.087	87pz	D	0-1-2	594,00



Supplementi certificati di taratura D2 (5 punti)

Codice	Prezzi	Comp	Gradi	Prezzo €
C555.032	32pz	A	0-1-2	262,00
C555.047	47pz	B-C	0-1-2	386,00
C555.087	87pz	D	0-1-2	714,00

Tabella composizione serie blocchetti di riscontro

Comp. A	Passo	N°
1,005	---	1
1,01 - 1,09	0,01	9
1,1 - 1,9	0,1	9
1 - 9	1	9
10 - 30	10	3
50	50	1

Comp. B	Passo	N°
1,005	---	1
1,01 - 1,19	0,01	19
1,2 - 1,9	0,1	8
1 - 9	1	9
10 - 100	10	10

Comp. C	Passo	N°
1,005	---	1
1,01 - 1,09	0,01	9
1,1 - 1,9	0,1	9
1 - 24	1	24
25 - 100	25	4

Comp. D	Passo	N°
1,001 - 1,009	0,001	9
1,01 - 1,49	0,01	49
0,5 - 9,5	0,5	19
10 - 100	10	10

Codice	Pezzi	Grado	Prezzo €
Composizione A			
510.032	32pz	0	328,00
511.032	32pz	1	210,00
512.032	32pz	2	125,00

Codice	Pezzi	Grado	Prezzo €
Composizione B			
510.047	47pz	0	450,00
511.047	47pz	1	309,00
512.047	47pz	2	165,00

Codice	Pezzi	Grado	Prezzo €
Composizione C			
511.048	47pz	1	318,00

Codice	Pezzi	Grado	Prezzo €
Composizione D			
510.087	87pz	0	650,00
511.087	87pz	1	388,00
512.087	87pz	2	239,00

Tabella precisione blocchetti di riscontro

Misura nominale in mm	Oltre	Fino a
10		10
25		25
50		50
75		75
100		100

Grado 0	
Scostamento µm	Planarità µm
± 0,12	0,10
± 0,14	0,10
± 0,20	0,10
± 0,25	0,12
± 0,30	0,12

Grado 1	
Scostamento µm	Planarità µm
± 0,20	0,16
± 0,30	0,16
± 0,40	0,18
± 0,50	0,18
± 0,60	0,20

Grado 2	
Scostamento µm	Planarità µm
± 0,45	0,30
± 0,60	0,30
± 0,80	0,30
± 1,00	0,35
± 1,20	0,35



da € 1082,00

521.047

Codice	Pezzi	Grado	Prezzo €
Composizione B			
521.047	47pz	0	1363,00
522.047	47pz	1	1082,00
Composizione C			
521.048	47pz	0	1363,00
522.048	47pz	1	1082,00



da € 595,00

513.108



€ 85,00

513.000

513.000 Connettore blocchetti oltre 125 85,00

Tabella composizione serie blocchetti di riscontro

Comp. K	Passo	N°
25 - 200	25	8

Comp. L	Passo	N°
125 - 200	25	4
250	- - -	1
300 - 500	100	3

Codice	Pezzi	Grado	Prezzo €
Composizione K			
514.008	8pz	0	850,00
514.108	8pz	1	595,00
C514.008	Supplemento cert. Accredia		524,00
Composizione L			
513.008	8pz	0	1560,00
513.108	8pz	1	1020,00
C513.008	Supplemento cert. Accredia		640,00

Tabella di precisione blocchetti di riscontro lunghi

Misura nominale in mm	Oltre	Fino a
100	100	150
150	150	200
200	200	250
250	250	300
300	300	400
400	400	500
500	500	600

Grado 0	
Scostamento µm	Planarità µm
±0,40	0,14
±0,50	0,15
±0,60	0,16
±0,70	0,19
±0,90	0,20
±1,10	0,25
±1,30	0,25

Grado 1	
Scostamento µm	Planarità µm
±0,80	0,20
±1,00	0,25
±1,20	0,25
±1,40	0,30
±1,90	0,30
±2,20	0,35
±2,60	0,40

Grado 2	
Scostamento µm	Planarità µm
±1,60	0,40
±2,00	0,40
±2,40	0,45
±2,80	0,50
±3,60	0,50
±4,40	0,60
±5,00	0,70

Blocchetti di riscontro con anelli - Controllo calibri e micrometri



da € 195,00

515.010

516.204

Codice	Pezzi	Grado	Prezzo €
Serie 10pz per micrometri 0:25			
2,5 - 5,1 - 7,7 - 10,3 - 12,9 - 15,0 - 17,6 - 20,2 - 22,8 - 25,0			
515.010	10pz	1	195,00
C515.010	Supplemento cert. Accredia		85,00

Codice	Pezzi	Grado	Prezzo €
Serie 3+2pz per calibri 0:25			
Blocchetti 30,0 - 41,3 - 131,4 - Anello Ø4 - Ø25			
516.204	5pz	1	207,50
C516.254	Supplemento cert. Dakks		257,00

Blocchetti angolari - Controllo squadre e goniometri

ACCREDIA Certificati e RDT a richiesta

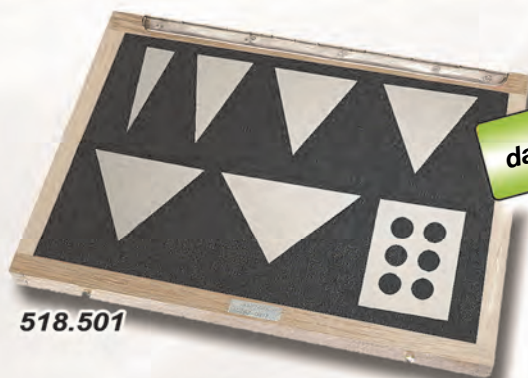

da € 299,00

518.501

Codice	Pezzi	Grado	Prezzo €
15°10' - 30°20' - 45°30' - 50° - 60°40' - 75°50' - 90°			
518.501	7pz	1	434,00
518.501A	7pz	2	299,00



da € 86,00

006.708

Gli assortimenti possono variare (vedi foto):
Alcuni vengono forniti con canotti, altri senza
Il colore del legno degli astucci può variare



da € 216,00

006.712

Assortimenti 0,01 fino a 1mm

Codice	Utile	Spine	Prog.	Prezzo €
006.697	0,2:0,5	31	0,01	86,00
006.698	0,2:1	81	0,01	175,00
006.699	0,5:1	51	0,01	146,00

Assortimenti 0,01 da 1 a 10mm

Codice	Utile	Spine	Prog.	Prezzo €
006.702	1,01:2	100	0,01	235,00
006.703	2,01:3	100	0,01	235,00
006.704	3,01:4	100	0,01	235,00
006.705	4,01:5	100	0,01	245,00
006.706	5,01:6	100	0,01	245,00
006.707	6,01:7	100	0,01	250,00
006.708	7,01:8	100	0,01	250,00
006.709	8,01:9	100	0,01	260,00
006.710	9,01:10	100	0,01	260,00

Assortimenti 0,01 da 10 a 20mm

Codice	Utile	Spine	Prog.	Prezzo €
006.711	10,01:11	100	0,01	312,00
006.712	11,01:12	100	0,01	312,00
006.713	12,01:13	100	0,01	320,00
006.714	13,01:14	100	0,01	371,00
006.715	14,01:15	100	0,01	371,00
006.716	15,01:16	100	0,01	423,00
006.717	16,01:17	100	0,01	423,00
006.718	17,01:18	100	0,01	468,00
006.719	18,01:19	100	0,01	485,00
006.720	19,01:20	100	0,01	495,00

Assortimenti decimali

Codice	Utile	Spine	Prog.	Prezzo €
006.700	1:10	91	0,1	230,00
006.761	10:16	61	0,1	229,00
006.762	16:20	41	0,1	216,00

Novità

Morsetti e set morsetti portaspine - Per spine calibrate



da € 21,00

636.809

Codice	Ømin	Ømax	Dimens.	Prezzo €
636.801	0,28	1,51	Ø19L107	21,00
636.802	1,52	7,71	Ø28L140	30,00
636.803	7,72	12,71	Ø39L157	36,00
636.804	12,72	15,31	Ø33L148	43,50
636.805	15,32	17,81	Ø43L154	48,00
636.806	17,82	20,37	Ø45L154	55,00

Set completo 6 portaspine in astuccio alluminio

Codice	Ømin	Ømax	Prezzo €
636.809	0,28	20,37	165,00

Tamponi lisci Passa/Non Passa - Precisione H7 - Nuova produzione di alta qualità

Catalogo 5/15

ACCREDIA Certificati e RDT pagina 83



Codice	Ø Tamponi	Pezzi	Prezzo €
Cofanetti in alluminio o plastica			
575.002Q	3:12	7pz	174,00
575.000Q	3:30	28pz	894,00
575.001Q	32:62	16pz	996,00

Tamponi filettati Passa/Non Passa - Precisione 6H - Nuova produzione di alta qualità

Catalogo 5/17

ACCREDIA Certificati e RDT pagina 83



Sono fornibili a richiesta cofanetti da 7 o 21 pezzi anelli
Go (passa) o NoGo (non passa)

Codice	Ø Tamponi	Pezzi	Prezzo €
Cofanetti in alluminio o plastica			
572.100	3:12	7pz	142,00
572.000	3:14	13pz	222,00
572.200	2:30	21pz	399,00

Serie 50 sfere di precisione 0,0025 - Durezza circa 60 ±2HRC

Catalogo 5/14

ACCREDIA Certificati e RDT pagina 82



Codice	N.coppie	Misure	Prezzo €
* 006.690	25	Ø01-25	99,50

Tablette girevoli - Contenitore in plastica antipolvere - Filettature e tolleranze ISO

Catalogo 7/14



Codice	Descrizione	Prezzo €
410.350	Filetor	71,50
410.351	Tolerator	71,50



Collegando un comparatore della serie 004.95... il display del truschino mostra la somma dei 2 strumenti

Codice	Accessori	Prezzo €
009.697	Cavo truschino-comparatore	19,00

Codice	Utile	Letture	Precis.	Prezzo €
Comparatori catalogo 4A/21 rev. e promo pagina 34				
004.951	0:12	0,01	10 µm	99,50

Truschini inclusa punta a tracciare e supporto comparatore, optional a richiesta punta a tracciare tonda

Codice	Accessori	Prezzo €
009.699	P.ta tonda 87x37 attacco 8,5x9	43,00

Set completo da 300mm

€ 550,00

Il set comprende 009.693 + 009.697 + 004.951

Codice	Utile	Letture	Prezzo €
On/off - mm/inch - zero - hold - inc - origin			
009.693	300	0,01	502,00
009.696	600	0,01	727,00



Codice	Utile	Letture	Prezzo €
On/off - mm/inch - zero - preset+/- ABS - hold			
009.653	300	0,01/inch	197,50
009.655	500	0,01/inch	316,00
009.660	1000	0,01/inch	840,00

Codice	Utile	Letture	Prezzo €
On/off - mm/inch - zero - preset+/-			
009.683	300	0,01/inch	305,00
009.685	600	0,01/inch	545,00

ACCREDIA Certificati e RDT a richiesta



da € 356,00

da € 208,00

Codice	Utile	Letture	Prezzo €
<i>Letture doppio analogico e comparatore centesimale</i>			
006.023	300	mm + 0,01	208,00
006.025	500	mm + 0,01	310,00
006.026	600	mm + 0,01	368,00



Codice	Utile	Letture	Prezzo €
<i>On/off - mm/inch - zero - preset+/-</i>			
009.023	300	0,01/inch	356,00
009.026	600	0,01/inch	624,00
* 009.826E	600	0,01/inch	507,00

009.023

006.023

Truschini analogici - Vite micrometrica - Lente ed aste regolabili

ACCREDIA Certificati e RDT a richiesta



da € 79,00

da € 159,00

Codice	Utile	Letture	Prezzo €
<i>Il nonio può variare a seconda della disp. a magazzino</i>			
006.003	300	0,02 (0,05)	79,00
006.005	500	0,02 (0,05)	139,50
006.010	1000	0,02 (0,05)	490,00

Codice	Utile	Letture	Prezzo €
<i>Variante economica del 006.013</i>			
006.043	300	0,02	99,50

Codice	Utile	Letture	Prezzo €
<i>Asta regolabile - Lente - Vite micrometrica</i>			
006.013	300	0,02	159,00
006.015	500	0,02	194,00
006.016	600	0,02	243,00



Massimo 600 giri/minuto

Codice	Gambo	Cont. Ø	Lung.	Prezzo €
Centratori con finitura brunita				
009.681	Ø10	10	90	12,50
009.682	Ø10	10+4	90	13,50
Centratori con finitura rettificata				
009.671	Ø10	10	90	19,00
009.672	Ø10	10+4	90	20,00



Massimo 600 giri/minuto

Codice	Gambo	Cont. Ø	Lung.	Prezzo €
Centratori amagnetici ricoperti in TIN				
653.096	Ø10	10	90	48,00
653.097	Ø10	10+4	90	49,00
Centratori amagnetici ceramici				
653.091	Ø10	10	90	20,00
653.093	Ø10	10	90	47,00



Non farli girare in macchina!!!

Codice	Gambo	Sfera	Lung.	Prezzo €
009.659	Ø20	Ø10	100	69,50
009.662	Ø20	Ø10	160	79,00
009.663	Ø20	Ø10	160	89,00

ACCREDIA Certificati e RDT pagina 78



Codice	Corpo	Piatto	Altezza	Prezzo €
Azzeramento con 2 spine 50/100 incorporate				
009.648	57x65	Ø26	50	97,00
009.649	65x83	Ø26	100	162,00

Codice	Corpo	Piatto	Altezza	Prezzo €
Azzeramento con rotella laterale "preset"				
009.641	57x59	Ø32	50	142,50
009.642	58x80	Ø32	100	214,50

h 50 magnete permanente
h 100 magnete a levetta

Preset altezza h50 - Analogici con comparatore Ø40

Catalogo 8/7

ACCREDIA Certificati e RDT pagina 83

009.644Y

da € 141,00



Codice	Corpo	Piatto	Altezza	Prezzo €
Nuovo modello con contatto maggiorato - Magnetico				
009.644	Ø62	Ø46	50	141,00
* 009.644N	Ø62	Ø44	50	148,00
* 009.644Y	Ø62	Ø44	50	159,00

Preset altezza h50 - Tipo luminoso

Catalogo 8/7

ACCREDIA Certificati e RDT pagina 83



009.645

Codice	Corpo	Piatto	Altezza	Prezzo €
Non utilizzabili su macchine utensili con piano isolato				
009.645	Ø54	Ø11	50	122,00

Preset altezza h50 digitali - Risoluzione 0,01

Catalogo 8/9

ACCREDIA Certificati e RDT pagina 83

009.652
vista sup.



009.652



Codice	Corpo	Piatto	Letture	Prezzo €
* 009.652	Ø55	Ø25	0,01	108,00

Preset altezza h50 digitali - Risoluzione 0,001 - (009.654 IP65)

Catalogo 8/9

ACCREDIA Certificati e RDT pagina 83

da € 134,00



009.651

009.654



Codice	Corpo	Piatto	Letture	Prezzo €
* 009.651	Ø55	Ø25	0,001	134,00
* 009.654	Ø55	Ø25	0,001	155,00





653.101

€ 165,50

Codice	Attacco	Campo	Comp.	Prezzo €
Rotazione interna - Quadrante sempre in vista				
653.101	Ø10	0-300	Ø40	165,50



Ø16

richiesta

Ø16

IP67

975.901

975.501

Haff Schneider

Codice	Gambo	L totale	Comp.	Prezzo €
Digigraph con doppia lettura - IP67				
975.901	Ø16	134	Ø60	a richiesta
Analogico con scala proporzionale - IP67				
975.501	Ø16	134	Ø60	a richiesta
Codice	Puntalini di ricambio		Prezzo €	
975.511	Standard Ø4 - L31mm		a richiesta	
975.512	Lunghi Ø6 - L56,5mm		a richiesta	



Ø20

richiesta

Ø12

IP67

975.001

975.102

Codice	Gambo	L totale	Comp.	Prezzo €
FH modello Universal				
975.001	Ø20	163	Ø60	a richiesta
FH modello New Generation				
975.102	Ø12	126	Ø60	a richiesta
Codice	Puntalini per 975.001/101/102		Prezzo €	
975.011	Standard Ø4 - L31mm		a richiesta	
975.012	Lunghi Ø6 - L56,5mm		a richiesta	



Ø10

richiesta

Ø16

IP67

975.101

975.001C

Codice	Gambo	L totale	Comp.	Prezzo €
FH modello Zero Master				
975.101	Ø10	121	Ø40	a richiesta
Puntalini di ricambio vedere sopra - 975.011/012				
FH modello Centro				
975.001C	Ø16	192	Ø60	a richiesta
Codice	Puntalini di ricambio		Prezzo €	
975.011C	Diritto Ø4 mm		a richiesta	
975.011D	Diritto Ø2 mm		a richiesta	
975.011E	Curvo Ø4mm		a richiesta	



Codice	Apertura	L gan.	h gan.	Prezzo €
008.471	50	50	25	170,50
008.472	75	75	33	206,00
008.473	100	100	38	293,50



Codice	Lung. tot	Apertura	Gan LxH	Prezzo €
008.529	65	25	25x10	65,00
008.529A	100	40	36x25	70,00
* 008.829E	100	40	36x25	58,00
008.530	140	65	50x25	79,00
* 008.830E	140	65	50x25	60,00
008.530A	175	85	63x32	97,00
008.531	190	100	73x35	151,00
* 008.831E	190	100	73x35	130,00
008.532	245	125	100x45	210,00
* 008.832E	245	125	100x45	180,00
008.533	285	160	125x50	279,00
008.533A	330	200	150x50	425,00



Codice	Lung. tot	Apertura	Gan LxH	Prezzo €
008.516	155	60	50x25	110,00
008.516A	190	85	63x32	130,00
008.517	210	100	73x35	179,50
008.515	250	128	88x40	247,00
008.518	250	125	100x45	269,00
008.519	300	160	125x50	429,00
008.520	350	210	125x50	459,50

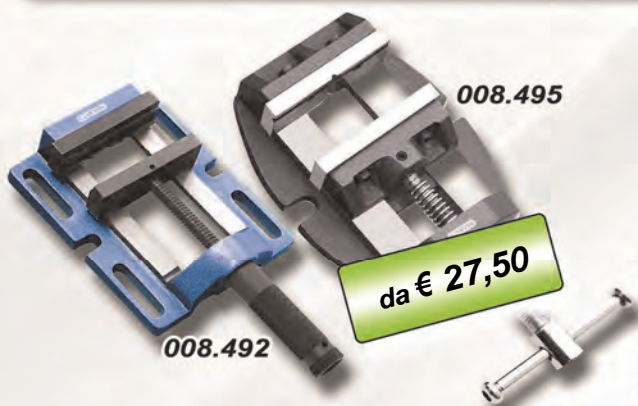

Codice	Apertura	L ganas	H ganas	Prezzo €
008.492	88	100	30	35,00
008.493	120	125	35	58,50
008.495	75	75	35	27,50
008.496	100	100	40	32,00



008.714



da € 105,00

Codice	Coppie	Lungh.	Spess.	Prezzo €
008.709	9	100	4	134,50
Larghezze: 10-14-18-22-26-30-34-38-42				
008.710	9	160	4	161,00
* 008.690E	9	160	4	105,00
Larghezze: 10-14-18-22-26-30-34-38-42				
008.714	14	150	10	259,00
* 008.694E	14	150	10	184,00
Larghezze: 14-16-18-20-22-24-26-28-30-32-35-40-45-50				



008.714HQ



da € 155,00

Codice	Coppie	Lungh.	Spess.	Prezzo €
* 008.709HQ	9	100	4	155,00
Larghezze: 10-14-18-22-26-30-34-38-42				
* 008.710HQ	9	160	4	207,00
Larghezze: 10-14-18-22-26-30-34-38-42				
* 008.712HQ	12	120	10	262,00
Larghezze: 14-16-18-20-22-24-26-28-30-32-35-40				
* 008.714HQ	14	150	10	315,00
Larghezze: 14-16-18-20-22-24-26-28-30-32-35-40-45-50				



008.541

da € 163,00

Codice	Standard	Prezzo €
DIN 2080 - DIN 69871 - MAS 403 BT		
008.540	ISO 30	182,00
008.541	ISO 40	163,00
008.542	ISO 50	207,00
HSK - PSC 26623-1 - Capto - KM		
008.546	HSK 63 A-B-C-D-E-F	199,00



008.544

€ 139,00



Codice	Standard	Prezzo €
DIN 2080 - DIN 69871 - MAS 403 BT		
* 008.544	ISO 40	139,00



Codice	Dimensioni	Cave a T	Prezzo €
008.621	Ø75 x h45	4 x 8mm	112,00
008.622	Ø100 x h55	4 x 8mm	152,00
008.623	Ø150 x h80	4 x 10mm	262,00
008.624	Ø200 x h108	4 x 13mm	467,00



Codice	Dimensioni	Cave a T	Prezzo €
008.631	Ø75 x h56	4 x 8mm	126,00
008.632	Ø100 x h66	4 x 8mm	221,00

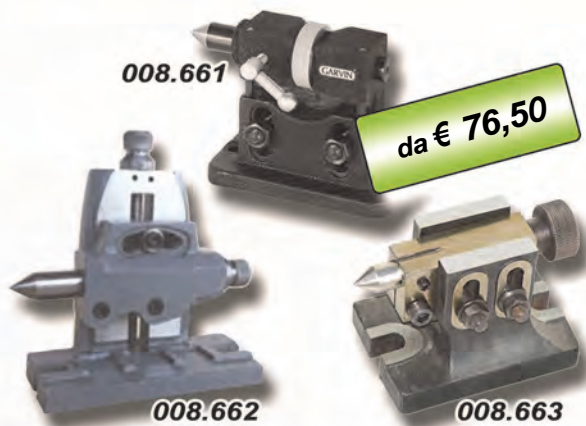

Codice	Descrizione	Prezzo €
008.661	Regol. 89-110 x tavole Ø100	76,50
008.662	Regol. 43-80 inclin. x tavole Ø75	89,00
008.663	Regol. 93-125 x tavole Ø100	81,00



Codice	Diam.	Tavola	Fori	Filetto	Prezzo €
008.641	Ø55	Ø75	2	M12	6,50
008.642	Ø55	Ø75	2	M14	6,50
008.643	Ø80	Ø100	4	M12	6,50
008.644	Ø80	Ø100	4	M14	6,50

Codice	Diam.	Tavole	Pinze	Prezzo €
008.651	Ø80	Ø75 e 100	ER16	40,00
008.652	Ø80	Ø75 e 100	ER25	40,00
008.653	Ø80	Ø75 e 100	ER32	47,00

Misure fino a diametro Ø250 a richiesta



Codice	Dimensioni	Cave a T	Prezzo €
008.526N	125x100x80	3 x T10	127,50
008.527N	175x125x95	3 x T12	175,00
008.528N	250x175x125	3 x T12	250,00
008.529N	380x250x170	3 x T12	403,00



Codice	Dimensioni	Cave a T	Prezzo €
008.536	125x100x22	2 x 8mm	153,00
008.537	200x150x28	3 x 10mm	338,00
008.538	250x200x40	3 x 12mm	422,00



Peso massimo del pezzo su contropunte 100Kg

Codice	Interasse	Punte h	Banco	Prezzo €
008.908	300	100	730	589,00
008.909	500	170	930	830,00
008.910	1000	170	1460	1177,00
008.911	1500	170	1960	1763,00

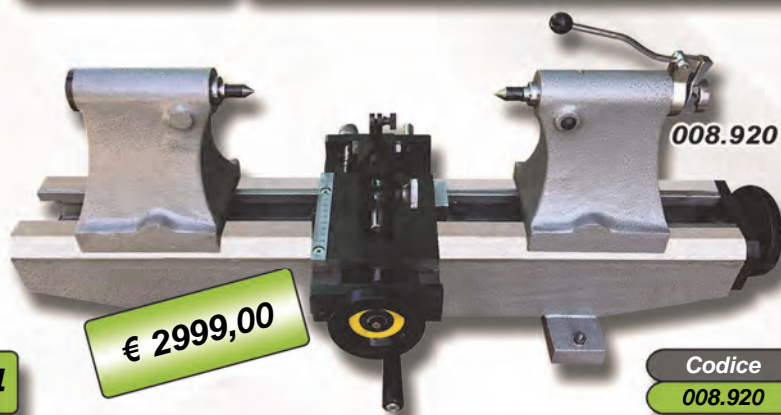

Codice	Ø max	Eliche da	mm max	Prezzo €
008.920	150mm	2-10	500mm	2999,00

Tavole verticali - Attacco fisso - Superficie rettificata - Cave a "T" fresate

Catalogo 8/29



Codice	Dim.	Cave a T	Corsa	Prezzo €
008.675	125x100	3x16mm	100mm	115,00

Codice	Dim.	Cave a T	Corsa	Prezzo €
008.685	90x50	9mm	70mm	76,50

Tavole verticali - Attacco rotante - Superficie rettificata - Cave a "T" fresate

Catalogo 8/29



Codice	Dim.	Cave a T	Corsa	Prezzo €
008.680	125x100	3x16mm	100mm	161,00

Morse tonde per tavole rotanti - Acciaio rettificato

Catalogo 8/12

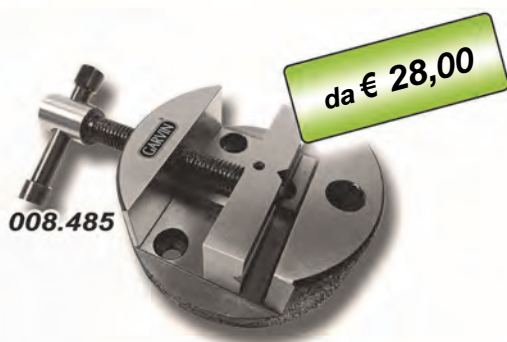

Codice	Ganasce	Apertura	X tavole	Prezzo €
008.485	80x20	40mm	Ø100	28,00
008.486	70x20	28mm	Ø75	35,00

Morse per tavole verticali - Superficie rettificata - 4 fori montaggio - (008.480 per mini tavole)

Catalogo 8/12

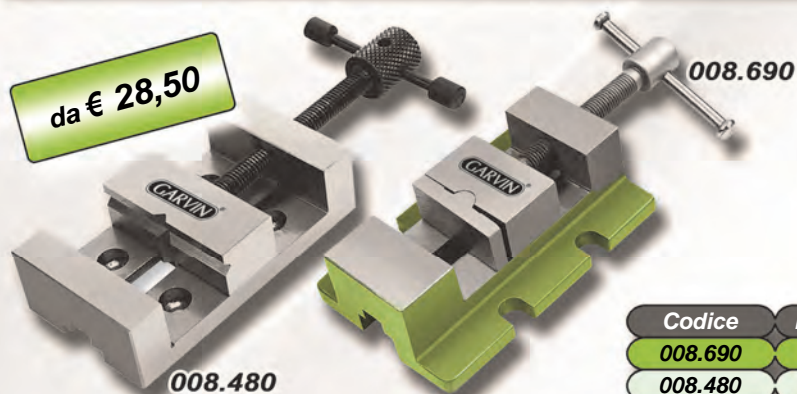

Codice	Lungh.	Prof.	Apertura	Prezzo €
008.690	45	35	30mm	28,50
008.480	50	18	50mm	38,50





Griffe a richiesta

Codice	Base	Altezza	Ø	Prezzo €
008.670	145x145	80	100	235,00

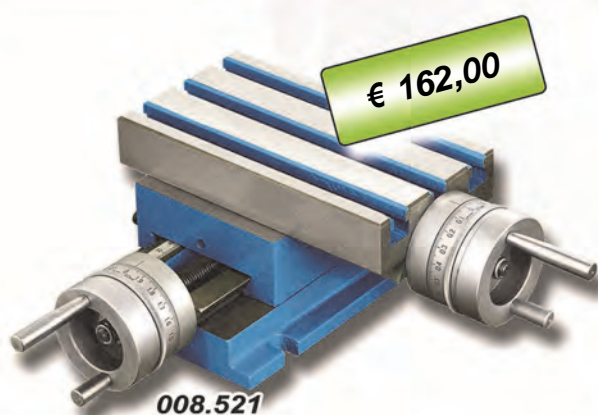

Codice	Dimensioni	Cave a T	Prezzo €
008.521	185x100x104	3x10mm	162,00



Griffe a richiesta

Codice	Dimensioni	Griffe	Prezzo €
* 008.600A	80mm	3+3	116,00
008.600	100mm	3+3	125,00
008.601	160mm	3+3	180,00
008.602	200mm	3+3	243,00
008.603	250mm	3+3	286,00



Griffe a richiesta

Codice	Dimensioni	Griffe	Prezzo €
008.610	100mm	4+4	179,00
008.611	160mm	4+4	196,50
008.612	200mm	4+4	223,50
008.613	250mm	4+4	277,00

Coppie prismi - Ghisa - Alleggeriti - Precisione ~10µm

Catalogo 8/22

ACCREDIA Certificati e RDT a richiesta



Codice	Dimensioni	Misura V	Prezzo €
504.201	50x25x32	25	27,00
504.202	75x32x60	44	42,50
504.203	100x41x65	50	52,00
504.204	125x50x80	50	67,00
504.205	150x63x90	82	112,00

Coppie paralleli a croce - Ghisa - Alleggeriti - Precisione ~10µm

Catalogo 8/22

ACCREDIA Certificati e RDT a richiesta



Codice	Dimensioni	Misure 4 V	Prezzo €
508.201	95x35x70	20x30x40x50	76,00
508.202	100x30x100	20x30x40x50	112,50
508.203	120x35x120	30x40x50x60	143,50
508.204	120x60x120	30x40x50x60	169,00
508.205	150x75x150	40x50x60x70	214,00
508.206	200x100x200	50x60x70x80	399,00

Coppie prismi - Acciaio temprato - Rettificati in coppia - Corpo senza scanalature

Catalogo 8/23

ACCREDIA Certificati e RDT a richiesta



Codice	Dimensioni	Misura V	Prezzo €
505.401	75x40x30	5-40	76,50
505.402	100x47x40	5-55	96,50
505.403	150x55x45	5-60	163,00
505.404	200x65x55	5-75	234,00

Coppie prismi - Acciaio temprato - Morsetti avvitabili - Precisione inferiore a 10µm

Catalogo 8/24

ACCREDIA Certificati e RDT a richiesta



Codice	Dimensioni	Alberi	Prezzo €
529.501	63x63x50	Ø5-41	145,50
529.501S	Prisma come sopra singolo		78,50
529.502	100x75x75	Ø5-57	299,00
529.502S	Prisma come sopra singolo		164,00



Codice	Dimensioni	Alberi	Prezzo €
529.303	70x63x45	Ø5-38	142,00
529.304	125x88x70	Ø5-54	362,00



Codice	Dimensioni	Larghezza V	Prezzo €
527.104	70x54x73	38/19	191,00
527.104S	Prisma c/s singolo		102,50
527.105	100x70x95	50/19	254,50
527.105S	Prisma c/s singolo		136,50
527.106	150x75x95	55/25	575,00
527.106S	Prisma c/s singolo		309,00



Codice	Dimensioni	Feritoie	Prezzo €
350.501	90x75x63	15	40,00
350.502	115x90x75	15	53,50
350.503	150x125x115	15	76,50
350.504	200x150x125	17	142,00
350.505	300x225x200	25	292,00



Codice	Dimensioni	Feritoie	Prezzo €
350.601	90x75x63	15	41,50
350.602	115x90x75	15	59,00
350.603	150x125x115	15	83,00
350.604	200x150x125	17	147,00
350.605	300x225x200	25	395,00

Punte a tracc. per frese/trapani - Punta in acc.temp. - Forza regolabile - Lime diamantate

Catalogo 6/6



da € 96,00

€ 10,00



670.030

Codice	Pezzi	Misure	Prezzo €
670.030	30	Ø3 x 45mm	10,00

Codice	Passo M	Filetto	Prezzo €
339.101	80(+20)-Ø12	Ø5 - L20	96,00
339.102	80(+20)-Ø16	Ø5 - L20	105,00

Raggimetri e contafiletti - Completamente in acciaio - Raggi e denti fresati

Cat. 7/20-21



da € 4,00

ACCREDIA Certificati e RDT a richiesta

Codice	Lame	Filetto/Utile	€
409.111	28	Whitworth 55° passo 62-4	4,00
409.112	24	Metrico 60° passo 0,25-6,0	5,00
409.113	52	Ww 62-4 - M 0,25-6,0	5,50
409.114	58	Ww 62-4 - M 0,25-6,0 - Gas 28-8	5,50

417.101	34	(Lame 17 int. e 17 est.) 1-7	7,50
417.102	32	(Lame 16 int. e 16 est.) 7,5-15	11,00
417.103	30	(Lame 15 int. e 15 est.) 15,5-25	11,00

Spessimetri a lame coniche - Acciaio inox - Lunghezza 100 x 12,7

Catalogo 7/18

ACCREDIA Certificati e RDT pagina 82



da € 3,00

Codice	Lame	Misure	Prezzo €
406.113	13	0,05-1,00	3,00
406.120	20	0,05-1,00	4,00
406.132	32	0,03-1,00	6,00

Bobine di nastro calibrato - Acciaio temprato - Custodia di plastica

Catalogo 7/17

ACCREDIA Certificati e RDT a richiesta



da € 7,50

Codice	Spessore	Lunghezza	Prezzo €
742.142	0,02	5mt	21,00
742.143	0,03	5mt	10,50
742.145	0,05	5mt	7,50
742.150	0,10	5mt	8,00
742.153	0,15	5mt	8,00
742.156	0,20	5mt	8,00
742.157	0,25	5mt	8,00
742.158	0,30	5mt	8,00
742.160	0,40	5mt	8,00
742.162	0,50	5mt	8,50



Codice	Misura	Peso	Prezzo €
697.900A	300x200x50	9Kg	61,50
697.901A	400x250x60	18Kg	89,50
697.902A	500x315x70	33Kg	138,00
697.903A	630x400x80	60Kg	179,50
697.904A	800x500x100	120Kg	324,00
697.905A	1000x630x140	260Kg	535,00
697.906A	1200x800x160	460Kg	883,00
697.907A	1600x1000x180	860Kg	1275,00



Codice	Piani	Misura	Prezzo €
698.903	630x400	530x350	276,50
698.904	800x500	700x400	288,50
698.905	1000x630	900x530	300,00
698.906	1200x800	1100x700	415,00
698.907	1600x1000	1400x800	461,00

Codice	Descrizione	Prezzo €
698.901	Set 4 piedini antivibranti	39,00



Codice	Misura	Peso	Prezzo €
682.001N	500x50x80	5Kg	178,00
682.002N	750x50x100	10Kg	259,50
682.003N	1000x60x140	23Kg	471,50
682.004N	1500x80x180	40Kg	788,00
682.005N	2000x100x200	80Kg	1205,00



Squadre grado 0 o 00 a richiesta

Codice	Misura	Peso	Prezzo €
681.001N	200x150x30	2Kg	113,00
681.002N	300x200x40	5Kg	132,50
681.008N	1200x800x140	210Kg	1512,00
681.009N	1500x1000x160	480Kg	1730,00

Bilance - Contapezzi da 3 a 30kg - Doppio display (frontale e retro)

Catalogo 9/7

VIDEO ISTRUZIONI



879.060



ACCREDIA Certificati e RDT a richiesta



Codice	Capacità	Risoluz.	Piatto	Prezzo €
879.030	3kg	0,1gr	25x18	99,00
879.060	6kg	0,2gr	25x18	99,00
879.150	15kg	1,0gr	25x18	99,00
879.300	30kg	1,0gr	25x18	105,00
* 879.530E	30kg	1,0gr	25x18	79,00

Bilance - Piattaforma da 100 a 300kg - Asta inclinabile

Catalogo 9/7

ACCREDIA Certificati e RDT a richiesta



879.410

Codice	Capacità	Risoluz.	Piatto	Prezzo €
879.410	100kg	20gr	30x40	123,00
879.415	150kg	50gr	30x40	146,00
879.430	300kg	50gr	45x60	236,00

Bilance Gru - Dinamometri per sollevamento pesi da 1000 a 5000kg

Catalogo 9/8

ACCREDIA Certificati e RDT a richiesta



879.630

Remote control

Codice	Capacità	Risoluz.	Peso	Prezzo €
879.610	1000kg	500gr	20kg	532,00
879.630	3000kg	1000gr	22kg	644,00
879.650	5000kg	2000gr	24kg	706,00

Torsiometri digitali - Mandrino Ø1,5-13mm - Uscita USB e RS 232

Fuori catalogo

ACCREDIA Certificati e RDT a richiesta



971.501

€ 399,00



RS232 + USB

Data-Hold - min/max - Peak/Hold
Unità Ncm - kgfcm - lbf·in
Protezione sovraccarica max 150%
Mantenimento valore di picco

Codice	Range	Risoluz.	Precis.	Prezzo €
971.501	147,1	0,1:1Ncm	±1,5%+5d	399,00

Novità

Dinamometri digitali - Trazione e spinta - 1-500kg - Stativi fino 20kg max

ACCREDIA Certificati e RDT a richiesta



€ 199,00



da € 261,50



da € 331,00



RS232 + USB



Codice	Kg	Risoluz.	Precis.	Prezzo €
* 970.601	1	1g	0,2%+1d	261,50
* 970.602	2	1g	0,2%+1d	270,00
* 970.720	200	10g	0,2%+1d	331,00
* 970.750	500	10g	0,2%+1d	348,50
Codice	Descrizione			Prezzo €
* 970.690	Stativi fino a 20Kg			199,00

Catalogo 9/20

Dinamometri digitali - Trazione e spinta - 5-20-100kg - Stativi fino 20kg max

ACCREDIA Certificati e RDT a richiesta



€ 599,50



€ 315,50

Codice	Kg	Risoluz.	Precis.	Prezzo €
970.620	20	10g	0,5%+1d	315,50



Micro SD 8 GB

Codice	Descrizione		Prezzo €
970.490	Stativo h500 - Base 250x230		599,50
970.491	Morsetto blocca oggetti		28,00



da € 336,50



RS232 + USB

Codice	Kg	Risoluz.	Precis.	Prezzo €
970.405	5	1g	0,4%+1d	336,50
970.500	100	50g	0,5%+1d	453,00



Codice	Pixel	Zoom	Angolo	Prezzo €
Monitor staccabile - Sonde da ordinare separatamente				
937.172	320x240	1x - 4x	12,7-305	219,00

Codice	Pixel	Lung.	Diam.	Prezzo €
Sonde per endoscopi 937.171-172 - Angolo 60°				
937.173	640x480	1000	Ø5,5	128,00
937.174	640x480	3000	Ø5,5	148,00
937.175	640x480	1000	Ø9	57,50
937.176	640x480	3000	Ø9	99,00
937.177	640x480	1000	Ø12	47,00
937.178	640x480	3000	Ø12	74,00

Codice	Lung.	Diam.	Angolo	Prezzo €
Prolunghe per sonde 937.173/178 - Ø18 - Angolo 60°				
937.185	1000	Ø18	60°	13,50
937.186	2000	Ø18	60°	20,00
937.187	3000	Ø18	60°	32,50
937.188	4000	Ø18	60°	44,00

Codice	Diam.	Particolari	Prezzo €
Set accessori per sonde (*1Cappa protettiva - *2 Magnetica *3 e *5 Specchio 90° - *4 Gancio - *6 Gancio magnetico)			
937.161	Ø5,5	1 - 2 - 3	14,50
937.162	Ø9	1 - 2 - 3 - 4	14,50
937.163	Ø12	4 - 5 - 6	14,50



Codice	Pixel	Zoom	Angolo	Prezzo €
Monitor staccabile - Sonde da ordinare separatamente				
937.191	800x480	1x - 4x	12,7-305	299,00

Codice	Pixel	Lung.	Diam.	Prezzo €
Sonde per endoscopi 937.191 - Angolo 60°				
937.195	640x480	1000	Ø9	63,00
937.196	640x480	3000	Ø9	84,50
937.197	640x480	1000	Ø12	49,00
937.198	640x480	3000	Ø12	74,00



App scaricabile gratuitamente

Codice	Pixel	Zoom	Angolo	Prezzo €
Speciale per smartphones - Inclusa sonda Ø9 x L1000				
937.181	640x480	V.Handy	60°	99,00



906.509TOP

Codice	Descrizione	Prezzo €
Durometri con display analogico		
906.501	Manuale	1448,00
906.509	Motorizzato	1557,00



da € 1448,00

906.501
(906.509 motorizzato)

Codice	Descrizione	Prezzo €
Durometri con display digitale		
906.505	Manuale	1498,00
906.510	Motorizzato	1669,00



da € 1498,00

906.505
(906.510 motorizzato)



€ 3152,00

906.901

Pre carica 10kgf - 98.07N
Carichi 60kgf - 100kgf - 150kgf

2 provini HRC 1 provino HRB
1 penetratore diamante 120° + 1 a sfera Ø1,5875
2 pianetti tondi Ø55 e Ø150 + 1 prismatico

HRA 20:88 - HRB 20:100 - HRC 20:70 - HRD 40:70
HRF 60:100 - HRG 30:94 - HRH 80:100 - HRK 40:100

Codice	Descrizione	Prezzo €
Durometri digitali e motorizzati		
906.901	RS232-Stampante incl.	3152,00



€ 500,00

€ 72,00

901.130

901.199

Codice	Parametri	Precis.	Prezzo €
Fornito con caricatore USB, spazzolino, laccio e custodia			
901.130	HL-HRC-HRB-HV-HB-HS...	±0,5%	500,00
901.199	Provino di taratura per durometri		72,00

Durometri digitali - Shore A - D - C e Provini in gomma per durometri - 10pz Shore A/D

Catalogo 9/14

ACCREDIA Certificati e RDT a richiesta



da € 93,00

009.620

009.621

009.622

Punta Ø 1,25x L2,5
smussata 35
Ø 0,79 penetrante

Punta Ø 2,5x L2,5
sferica
SR 5,5 penetrante

Punta Ø 1,25x L2,5
smussata 30°
SR 0,1 penetrante

Codice	Campo	Precis.	Letture	Prezzo €
Shore A per gomma soffice				
009.620	0:100 HA	2%	0,5 HA	93,00
Shore D per gomma dura e materiali plastici				
009.621	0:100 HD	2%	0,5 HD	93,00
Shore C per gomma piuma e spugna				
009.622	0:100 HC	2%	0,5 HC	96,00

Codice	Durezze nominali	Prezzo €
7 provini colorati Shore A		
009.600	34 - 40 - 55 - 67 - 78 - 85 - 91	112,50
3 provini colorati Shore D		
009.601	28 - 42 - 83	75,00

Durometri a rimbalzo - Incluso nuovo software - Sonda D intercambiabile

Catalogo 9/8

ACCREDIA Certif. e RDT provini pag.82



901.910

€ 897,00

Codice	Parametri	Precis.	Prezzo €
901.910	HL-HRC-HRB-HV-HB-HS	±0,5%	897,00

Nuovo software e uscita USB - Memo 600 gruppi

Durometri a rimbalzo - Stampante incorporata - Sonda D intercambiabile - Provino incluso

Fuori catalogo

ACCREDIA Certif. e RDT provini pag.82



901.160

€ 698,00

Codice	Parametri	Precis.	Prezzo €
901.160	HRC-HRB-HV-HB-HS-HRA-HSD	±0,5%	698,00

Compreso software e uscita USB

Durometri a rimbalzo - Sonda D intercambiabile

Catalogo 9/8

ACCREDIA Certif. e RDT provini pag.82



901.150

€ 599,00

VIDEO ISTRUZIONI



Codice	Parametri	Precis.	Prezzo €
901.150	HL-HRC-HRB-HV-HB	±6HLD	599,00

Memoria di 100 gruppi - Spessore minimo 5mm



€ 999,00

935.110



VIDEO ISTRUZIONI



Codice	Ra µm - Rz µm	Campionam.	Prezzo €
935.110	0,05:10 - 0,1:50	0,25-0,8-2,5	999,00

Precisione 0,01µm - Ripetibilità < 12%
4 parametri Ra, Rz, Rq, Rt
Valutazione L0,25 e 4mm - Velocità 1mm/sec

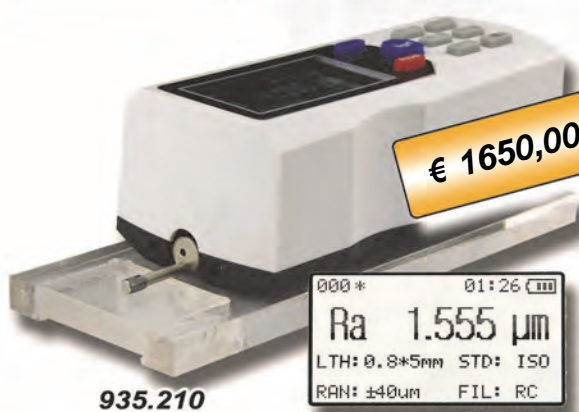

€ 1650,00

935.210

000 * 01:26
Ra 1.555 µm
LTH: 0,8*5mm STD: ISO
RAN: ±40µm FIL: RC

Display



Sonda



Codice	Ra µm - Rz µm	Campionam.	Prezzo €
935.210	0,005:16 - 0,02:160	0,25-0,8-2,5	1650,00

Precisione < ±10% - Ripetibilità < 6%
Ra 0,005 - Rz 0,02 + altri 11 parametri
Valutazione L1 e 4mm



935.905

€ 198,00



935.901

€ 1230,00



Rugosimetro a 2 parametri (Ra-Rz)

Codice	Ra µm - Rz µm	Campionam.	Prezzo €
* 935.901	0,05:10 - 0,005:100	0,25-0,8-2,5	1230,00



935.902

€ 1520,00

Rugosimetro a 4 parametri (Ra-Rz-Rq-Rt)

Codice	Ra µm - Rz µm	Campionam.	Prezzo €
* 935.902	0,005:16 - 0,02:160	0,25-0,8-2,5	1520,00

Codice	Descrizione	Prezzo €
* 935.905	Stativo portarugosimetro	198,00



935.462

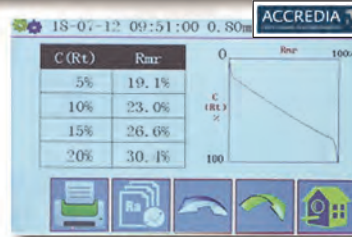

Assi



Parametri

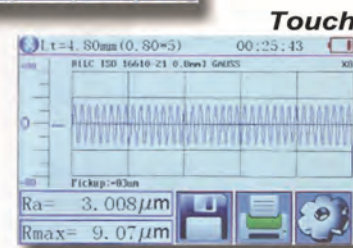

Sonda estratta

Codice	Campo misura	Campionam.	Prezzo €
935.462	160µm (-80/+80µm)	0,25-0,8-2,5	2382,00

Precisione $\leq \pm 7\%$ - Ripetibilità $< 6\%$ - Parametri Ra, Rz, Rq, Rt, Rp, Rv, R3z, R3y, Rz(JIS), Rs, Rsk, Rsm, Rku Rmr, Ry, Rmax, Rc - Velocità da 0,135 a 1mm/sec

Misuratori ad ultrasuoni - Nuovo software - Uscita USB



€ 607,00

945.930



ACCREDIA Certificati e RDT a richiesta

Nuovo software + uscita USB + 1 sonda dritta ed 1 ad angolo

Codice	Utile	Velocità	Errore	Prezzo €
945.930	0,75:300	1000:9999	$\pm(0,5\%+0,01)$	607,00

Memoria 2000 rilevamenti
Piastrina di azzerramento incorporata

Misuratori di spessori ad ultrasuoni

Novità



945.201

€ 386,00



ACCREDIA Certificati e RDT a richiesta

Codice	Utile	Velocità	Errore	Prezzo €
* 945.201	0,75:225	1000:9999	$\pm(0,5\%+0,1)$	386,00

Risoluzione 0,001mm oppure 0,1mm
Errore 1:10mm $\pm 0,05$ mm



Codice	Ottico	Contatto	V.m/min	Prezzo €
947.501	5:99999	0,5:19999	0,05:1999	199,00



Risoluzione 0,1 RPM < 1000 RPM (oltre 1 RPM)
 Risoluzione contametri 0,01m/min < 100m/min (oltre 0,1)
 Precisione ± (0,05% + 1 digit)

Codice	Ottico	Contatto	V.m/min	Prezzo €
947.601	10:99999	0,5:19999	0,05:1999	277,00



Tutti i modelli sono forniti con la memoria:
 Valore min/max - Ultimo valore
 Capacità memoria 96 dati

Codice	RPM Ottico	Precisione	Prezzo €
* 947.601E	2,5-99999	±0,05%+1d	61,00
Risoluzione 0,1RPM (2,5-999,9) oltre 1RPM			

Codice	RPM Contatto	Precisione	Prezzo €
* 947.602E	0,5-19999	±0,05%+1d	65,00
Risoluzione 0,1RPM (0,5-999,9) oltre 1RPM			
Velocità superficie 0,05-1.999,9			

Codice	RPM Contatto	Precisione	Prezzo €
* 947.603E	0,5-19999	±0,05%+1d	99,00
Risoluzione 0,1RPM (2,5-999,9) oltre 1RPM			



ACCREDIA Certificati e RDT a richiesta



€ 256,00

946.501

€ 114,50



946.505

Ellisse asse lunga 8, asse corta 4 - Memoria 100 gruppi

Codice	Gloss	Risoluz.	Errore	Prezzo €
946.501	200 GU	0,1 GU	1 GU	256,00
946.505	Stampante termica			114,50

ACCREDIA Certificati e RTD a richiesta



da € 440,00

946.511



Gloss	Gloss	Gloss
2000	1000	160
Angolo 20°	Angolo 60°	Angolo 85°
Elisse 10x10	Elisse 9x15	Elisse 5x38
Risoluzione 1,0GU	Risoluzione 0,1GU	Risoluzione 0,1GU

Codice	Gloss	Risoluz.	Errore	Prezzo €
Strumento a 60° per vernici				
946.511	1000 GU	0,1 GU	1 GU	440,00
Strumenti a 20-60-85° per vernici e metalli lucidi				
946.531	2000 GU	0,1 GU	1 GU	998,00

ACCREDIA Certificati e RDT a richiesta



980.601



RS232 + USB



Micro SD 8 GB

€ 327,50

Classe I

Codice	Portata dB	Hz	Prezzo €
980.601	30:80-50:100-80:130	31,5:16000	327,50

Precis. pesature A (orecchio umano) e C (rumore macchine)

KHz	0,03	0,06	0,12	0,25	0,5	1	2	4	8
db±	2	1,5	1,5	1,4	1,4	1,1	1,6	1,6	2,1

ACCREDIA Certificati e RDT a richiesta



€ 68,00

982.415



Capacità 35-130dB Pesatura A/C
Precisione ±2dB

Codice	Portata dB	Hz	Prezzo €
* 982.415	30:70-60:100-90:130	125-8000	68,00



da € 7,50

Codice	Sonda	Range	Prezzo €
Sonde K per termometri 963-964-965			
963.001	A filo	-40:250°C	7,50
963.002	Standard	-50:900°C	67,00
963.003	Alte temper.	-50:1200°C	101,00
963.004	Superficie	-50:400°C	132,00



€ 159,00

Codice	Range	Precisione	Prezzo €
Termometro con doppio ingresso solo per sonde K			
963.916	-50:1230°C	±1%+1°C	159,00



€ 217,00

Codice	Range	Precisione	Prezzo €
Termometro doppio ingresso per sonde 100Ohm platino o K			
964.917	-100:1370°C	±0,1% o 0,2°C	217,00
964.100	Sonda 100Ohm x 964 - 50:400°C		135,00

RS232 + USB

964.917 e 965.901 possono utilizzare anche la Sonde K perdendo leggermente di precisione



€ 196,50

Codice	Range	Precisione	Prezzo €
Termometro con 4 ingressi per sonde 100Ohm platino o K			
965.901	-250:1370°C	±0,5%	196,50
964.101	Sonda 100Ohm x 965 - 50:400°C		135,00



Micro SD 8 GB

RS232 + USB



da € 5,00



Codice	Range	Precisione	Prezzo €
* 963.900E	-50:1300°C	±0,3%-2°C	63,50

Codice	Sonda	Range	Prezzo €
Sonde K per termometri 963.900E			
* 963.901E	A filo	-40:200°C	a richiesta
* 963.902E	Standard L80	-50:400°C	a richiesta
* 963.903E	Standard L150	-50:400°C	15,00
* *963.904E	Superficie	-50:400°C	48,00



€ 63,50



Sonde 963.901E e 963.902E include

963.900E

Termometri ad infrarossi per temperatura corporea - Allarme sonoro - Retroilluminazione **Fuori catalogo**



Codice	Range	Precis.	Risoluz.	Prezzo €
960.100	32-42,5°C	0,3°C	0,1°C	65,00

Termometri digitali - Raggi infrarossi - Puntatore laser **Fuori catalogo**

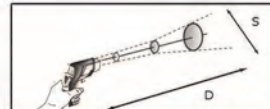

Indica il \varnothing della superficie misurata S rispetto alla distanza D

Codice	Range°C	D:S	Precis.	Prezzo €
* 960.350E	-25:400	10:1	$\pm 2\% + 1^\circ\text{C}$	54,50

Modello economico con raggi infrarossi e puntatore laser
Puntatore laser - Risoluzione 1°C - Funzione Hold

Codice	Range°C	D:S	Precis.	Prezzo €
* 960.520E	-30:520	10:1	$\pm 1,5\% + 1^\circ$	68,00

Modello economico con raggi infrarossi e puntatore laser
Puntatore laser - Risoluzione 0,5°C - Funzione Hold

Termometri digitali - Raggi infrarossi - Puntatore laser **Catalogo 9/22**

ACCREDIA Certificati e RDT pagina 82

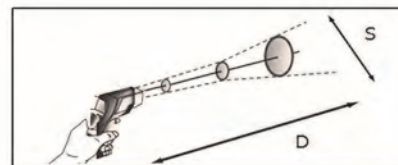

Indica il \varnothing della superficie misurata S rispetto alla distanza D

Codice	Range°C	D:S	Precis.	Prezzo €
960.101	-20:400	7:1	$\pm 3\%$	221,50

Modello medio con ingresso sonde K (-50:1230°C)
Puntatore laser - Memorizzazione min/max - Funzione Hold

Codice	Range°C	D:S	Precis.	Prezzo €
960.201	-30:1000	50:1	$\pm 2\%$	280,00

Modello Top della gamma con ingresso sonde K
2 puntatori laser - Memorizzazione min/max - Funzione Hold

Codice	Range°C	D:S	Precis.	Prezzo €
960.301	-30:305	7:1	$\pm 3\%$	99,50

Modello di dimensioni ridotte
Puntatore laser

ACCREDIA Certificati e RTD a richiesta



Software ed uscita USB
1 sonda diritta + 1 sonda ad angolo
Calibrazione automatica sui provini
Alta frequenza di campionamento con rumore basso

Codice	Campo	m/sec	Prec.	MHz	Prezzo €
945.510	0:6000	>11000	≤3%	0,4:15	2496,00
945.953	0:10000	>20000	≤2%	0,5:20	3997,00

Risoluzione 0,1mm (2,5:100mm, oltre 1mm)
Errore orizzontale lineare ≤0,1%
Velocità del suono 1000m/s : 15000m/s
Memo 980 scansioni

ACCREDIA Certificati e RDT a richiesta



Compreso software e uscita USB - Memo 500 gruppi

Codice	Substr.	µm	Precis.	Prezzo €
915.232	Ferroso	0:1250	±3%+1	460,00
915.233	Non ferr.	0:1250	±3%+1	460,00
Codice	Sonde intercambiabili		Prezzo €	
915.238	Sonda di ricambio/add. Fe		139,00	
915.239	Sonda di ricambio/add. NFe		139,00	

ACCREDIA Certificati e RDT a richiesta



Nuovo software e uscita USB - Memo 1560 gruppi

Codice	Substr.	µm	Precis.	Prezzo €
915.920	Ferroso	0:1250	±2%+1	594,00
915.921	Non ferr.	0:1250	±2%+1	594,00
Codice	Sonde intercambiabili		Prezzo €	
915.928	Sonda di ricambio/add. Fe		139,00	
915.929	Sonda di ricambio/add. NFe		139,00	

ACCREDIA Certificati e RDT a richiesta



Area minima Ø10mm
Curvatura convessa 5 - concava 20
Inclusi 2 provini Fe e NFe + 5 spessori
Risoluzione 0,1µm

Codice	µm	Precisione	Prezzo €
915.205	0:1250	±(1:3%)+1	296,00

Vibrometri digitali - Carta SD - Uscita USB e RS232

Fuori catalogo



ACCREDIA Certificati e RDT a richiesta



RS232 + USB



Micro SD 8 GB

Gamma di frequenza 10Hz : 1kHz
Errore dati $\leq 0,1\%$ di tutti i dati memorizzati

Codice	Acc m/s ²	Vel mm/s	Spont.	Prezzo €
972.501	0,5:199,9	0,5:199,9	1,999mm	379,00

Luxmetri - Carta SD - Ingresso sonde K per misurazioni di temperatura

Catalogo 9/19



ACCREDIA Certificati e RDT a richiesta



RS232 + USB



Micro SD 8 GB

Risoluzione Lux 1 (2000) - 10 (20000) - 100 (100000)
Temperature con sonde K -50:1300°C

Codice	Campi di misura Lux	Precis.	Prezzo €
967.701	2000-20000-100000	$\pm 4\% + \text{dig}$	136,00

Analizzatori di colori - Area cromatica RGB/HSL - Sonda esterna

Catalogo 9/17



ACCREDIA Certificati e RDT a richiesta

Codice	Misurazioni	Prezzo €
966.501	Fono-Igro-Anemo-Lux-Termo	119,00

Temperature con sonda K (esclusa) -50:1300°C



RS232 + USB

Fonometro 35:130dB (Classe II)
Igrometro 10:95% e temperature 0:50°C
Luxmetro 0:20000Lux
Anemometro 0,4:30m/s - 1,4:108km/h

Rilevatore di perdite di gas - Allarme acustico/ottico

Novità



ACCREDIA Certificati e RDT a richiesta



Errore $\pm 2\%$ - Tempo di risposta <3s
Temperatura -5°C/50°C - Umidità <90%RH

Codice	Campi mis.	Risoluzione	Prezzo €
985.203	0:10.000ppm	1ppm-0,1%	142,00

Novità**Rilevatore di monossido di carbonio (CO) e densità****€ 122,00****985.200**

Codice	Campo di mis.	Risoluzione	Prezzo €
* 985.200	0-1000ppm	1ppm	122,00

Errore $\leq \pm 5\%$
 Tempo di risposta $< 30\text{sec}$
 Rilevazione di gas tossici o dannosi

Novità**Rilevatore di saturazione ossigeno (O₂) - Allarme acustico/optico****€ 186,00****985.201**

Codice	Campo di mis.	Risoluzione	Prezzo €
* 985.201	0-25%(vol)	0,1%(vol)	186,00

Errore $\pm 0,5\%$
 Applicazioni ed usi in posti di lavoro, in autoveicoli, etc
 Misurazioni O₂ in minerali - Densità O₂ in alta montagna

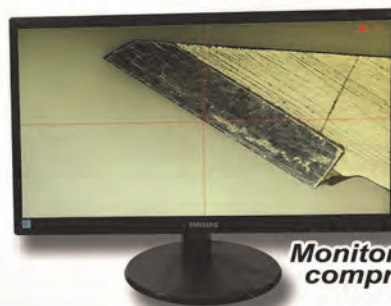
Novità**Videomicroscopio con autofocus rapido - Senza monitor****936.201****€ 2500,00****3 tipi di illuminazione****Monitor non compreso**

Luci	Episcopica+Diascopica+Coassiale
Ingrandimento monitor (1-6X)	Min. 29,92-179,5X - Max. 192,34-1.154X
Ingrandimento obiettivo	0,7-4,5X
Risoluzione ottica	Min. $< 8,77 \mu\text{m}$ - Max. $< 3,94 \mu\text{m}$
Distanza focale	88 +/-2 mm
Campo visivo FOV (D*H*V) mm	Min. 18,3*15,9*8,95 - Max. 2,84*2,47*1,39
Videocamera sensore - risoluzione	CMOS Color - 2MP
Uscita dati / Uscita video	USB / HDMI
Altezza max. pezzo	50 mm
Dimensioni	320x308,5x417,5 mm
Monitor colori	non incluso

Codice	Descrizione	Prezzo €
* 936.201	Videomicroscopio	2500,00



996.801-802

da € 81,00

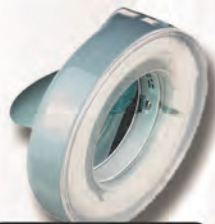

996.801 Neon



996.802 90 Led

Codice	ØLente	Luce	Watt	Prezzo €
996.801	127	Neon	22W	81,00
996.802	127	90 Led	7W	96,00
Lente fissa a 5 diottrie				



996.804

€ 29,50



da € 69,50

Codice	Descrizione	Prezzo €
996.803	Stativo a 4 ruote girevoli	26,00
996.804	Stativo tondo da tavolo	29,50



Lente intercambiabile

996.901-902

Codice	ØLente	Luce	Watt	Prezzo €
996.901	127	Neon	22W	69,50
996.902	127	60 Led	12W	73,00
Lente fissa a 8 diottrie				



€ 26,00

Codice	ØLente	Luce	Watt	Prezzo €
996.903	127	60 Led	12W	90,00
996.904	150	60 Led	12W	111,00
2 lenti intercambiabili a 3+20 e 5+20 diottrie				
Con dimmer solo modello 996.904				



996.803

da € 90,00



996.903-904

€ 10,00



996.905

Codice	ØLente	Luce	Watt	Prezzo €
996.905	150	---	---	10,00
Solo lente intercambiabile a 8 - 10 - 12 - 15 diottrie				



996.821



996.820



996.811



996.810

Codice	Altezza	Corpo	Consumo	Prezzo €
<i>Alogena 24V - 50W</i>				
996.821	110	Ø90	50W	69,00
996.820	650	Ø90	50W	141,00

Codice	Altezza	Corpo	Consumo	Prezzo €
<i>Alogena 24V con griglia di protezione - IP54 - 50W</i>				
996.811	110	Ø125	50W	88,00
996.810	890	Ø125	50W	151,50



996.830



996.831

Codice	Altezza	Corpo	Consumo	Prezzo €
<i>Led 24V - IP54 - 8W</i>				
996.831	110	Ø125	8W	186,00
996.830	890	Ø125	8W	238,00

PROMO 2020

CERTIFICAZIONI ACCREDIA e RAPPORTI DI TARATURA



Precedentemente



**Alcuni articoli esteri possono essere consegnati in alternativa
con certificati tedeschi o inglesi con la stessa validità**



Precedentemente

DKD



Consegna media 10/15gg

**I certificati normalmente vengono intestati alla Vogel s.r.l.
Al momento dell'ordine è possibile comunicarci i dati dell'intestatario finale.
Per una modifica a posteriori sarà applicato il costo di € 36,00**

**I prezzi includono i trasporti andata e ritorno da noi al
laboratorio, non quelli dall'utensiliere a noi e viceversa.**

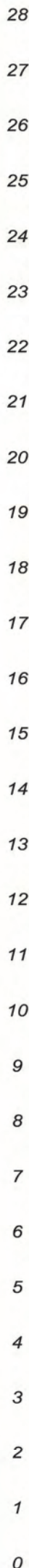

28
27
26
25
24
23
22
21
20
19
18
17
16
15
14
13
12
11
10
9
8
7
6
5
4
3
2
1
0

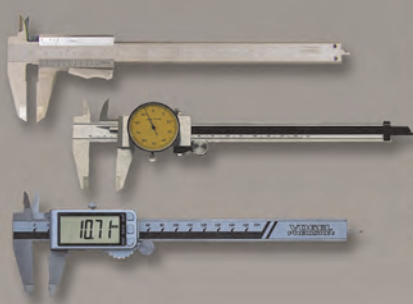

C001.150	ACCREDIA <small>UNIVERSITÀ ITALIANA DI ACCREDITAMENTO</small>	Calibri nonio/orologio/digitali fino 150	90,00
C001.200	ACCREDIA <small>UNIVERSITÀ ITALIANA DI ACCREDITAMENTO</small>	Calibri nonio/orologio/digitali oltre 150 fino 200	92,00
C001.300	ACCREDIA <small>UNIVERSITÀ ITALIANA DI ACCREDITAMENTO</small>	Calibri nonio/orologio/digitali oltre 200 fino 300	115,00
R001.150	R.D.T.	Calibri nonio/orologio/digitali fino 150	31,00
R001.200	R.D.T.	Calibri nonio/orologio/digitali oltre 150 fino 200	33,00
R001.300	R.D.T.	Calibri nonio/orologio/digitali oltre 200 fino 300	49,00



C001.500	ACCREDIA <small>UNIVERSITÀ ITALIANA DI ACCREDITAMENTO</small>	Calibri nonio/digitali oltre 300 fino 500	125,00
C001.1000	ACCREDIA <small>UNIVERSITÀ ITALIANA DI ACCREDITAMENTO</small>	Calibri nonio/digitali oltre 500 fino 1000	260,00
R001.500	R.D.T.	Calibri nonio/digitali oltre 300 fino 500	86,00
R001.800	R.D.T.	Calibri nonio/digitali oltre 500 fino 800	118,00
R001.1000	R.D.T.	Calibri nonio/digitali oltre 800 fino 1000	130,00
R001.3000	R.D.T.	Calibri nonio/digitali oltre 1000 fino 3000	richiesta



C002.025	ACCREDIA <small>UNIVERSITÀ ITALIANA DI ACCREDITAMENTO</small>	Micrometri nonio/contatore/digitali 0:25	81,00
C002.050	ACCREDIA <small>UNIVERSITÀ ITALIANA DI ACCREDITAMENTO</small>	Micrometri nonio/contatore/digitali 25:50	92,00
C002.075	ACCREDIA <small>UNIVERSITÀ ITALIANA DI ACCREDITAMENTO</small>	Micrometri nonio/contatore/digitali 50:75	103,00
C002.100	ACCREDIA <small>UNIVERSITÀ ITALIANA DI ACCREDITAMENTO</small>	Micrometri nonio/contatore/digitali 75:100	114,00

Riscontri non compresi - Non viene controllata la planarità

R002.025	R.D.T.	Micrometri nonio/contatore/digitali 0:25	29,00
R002.050	R.D.T.	Micrometri nonio/contatore/digitali 25:50	32,00
R002.075	R.D.T.	Micrometri nonio/contatore/digitali 50:75	34,00
R002.100	R.D.T.	Micrometri nonio/contatore/digitali 75:100	36,00
R002.125	R.D.T.	Micrometri nonio/contatore/digitali 100:125	47,00
R002.150	R.D.T.	Micrometri nonio/contatore/digitali 125:150	51,00
R002.175	R.D.T.	Micrometri nonio/contatore/digitali 150:175	56,00
R002.200	R.D.T.	Micrometri nonio/contatore/digitali 175:200	61,00
R002.225	R.D.T.	Micrometri nonio/contatore/digitali 200:225	69,00
R002.250	R.D.T.	Micrometri nonio/contatore/digitali 225:250	75,00
R002.275	R.D.T.	Micrometri nonio/contatore/digitali 250:275	83,00
R002.300	R.D.T.	Micrometri nonio/contatore/digitali 275:300	92,00



C002.025R	ACCREDIA <small>UNIVERSITÀ ITALIANA DI ACCREDITAMENTO</small>	Riscontri 25	79,00
C002.050R	ACCREDIA <small>UNIVERSITÀ ITALIANA DI ACCREDITAMENTO</small>	Riscontri 50	81,00
C002.100R	ACCREDIA <small>UNIVERSITÀ ITALIANA DI ACCREDITAMENTO</small>	Riscontri 75 o 100	88,00
C002.200R	ACCREDIA <small>UNIVERSITÀ ITALIANA DI ACCREDITAMENTO</small>	Riscontri oltre 100 fino 200	115,00
C002.300R	ACCREDIA <small>UNIVERSITÀ ITALIANA DI ACCREDITAMENTO</small>	Riscontri oltre 200 fino 300	125,00

Verifica della misura attraverso 1 punto centrale

R002.050R	R.D.T.	Riscontri 50	19,00
R002.100R	R.D.T.	Riscontri 75 o 100	21,00
R002.200R	R.D.T.	Riscontri oltre 100 fino 200	36,00
R002.300R	R.D.T.	Riscontri oltre 200 fino 300	49,00

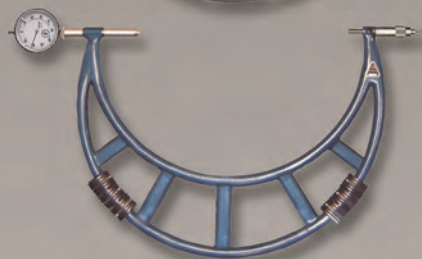

C002.401	ACCREDIA	Micrometri nonio/orol. incudini regolabili 300:400	253,00
C002.501	ACCREDIA	Micrometri nonio/orol. incudini regolabili 400:500	285,00
C002.601	ACCREDIA	Micrometri nonio/orol. incudini regolabili 500:600	290,00
C002.701	ACCREDIA	Micrometri nonio/orol. incudini regolabili 600:700	295,00
C002.801	ACCREDIA	Micrometri nonio/orol. incudini regolabili 700:800	315,00
C002.901	ACCREDIA	Micrometri nonio/orol. incudini regolabili 800:900	325,00
C002.1001	ACCREDIA	Micrometri nonio/orol. incudini regolabili 900:1000	340,00

Riscontri non compresi - Non viene controllata la planarità

R002.401	R.D.T.	Micrometri nonio/orol. incudini regolabili 300:400	117,00
R002.501	R.D.T.	Micrometri nonio/orol. incudini regolabili 400:500	147,00
R002.601	R.D.T.	Micrometri nonio/orol. incudini regolabili 500:600	161,00
R002.701	R.D.T.	Micrometri nonio/orol. incudini regolabili 600:700	177,00
R002.801	R.D.T.	Micrometri nonio/orol. incudini regolabili 700:800	191,00
R002.901	R.D.T.	Micrometri nonio/orol. incudini regolabili 800:900	199,00
R002.1001	R.D.T.	Micrometri nonio/orol. incudini regolabili 900:1000	215,00

C002.400R	ACCREDIA	Riscontri oltre 300 fino 400	121,00
C002.500R	ACCREDIA	Riscontri oltre 400 fino 500	125,00
C002.600R	ACCREDIA	Riscontri oltre 500 fino 600	135,00
C002.650R	ACCREDIA	Riscontri oltre 600 fino 650	140,00

Verifica della misura attraverso 1 punto centrale

R002.400R	R.D.T.	Riscontri oltre 300 fino 400	60,00
R002.500R	R.D.T.	Riscontri oltre 400 fino 500	73,00
R002.600R	R.D.T.	Riscontri oltre 500 fino 600	99,00
R002.700R	R.D.T.	Riscontri oltre 600 fino 680	103,00
R002.1000R	R.D.T.	Riscontri oltre 900 fino 1000	175,00

C002.241	ACCREDIA	Testine micrometriche a nonio 0:25 o 0:50	89,00
C009.281	ACCREDIA	Testine micrometriche digitali 0:25 o 0:50	92,00

R002.241	R.D.T.	Testine micrometriche a nonio 0:25 o 0:50	32,00
R009.281	R.D.T.	Testine micrometriche digitali 0:25 o 0:50	35,00

C002.181	ACCREDIA	Micrometri di profondità 0:25 fisso o con 1 asta	125,00
C002.181P	ACCREDIA	Ogni asta supplementare fino a 300	50,00

R002.181	R.D.T.	Micrometri di profondità 0:25 o 0:50	60,00
R002.183	R.D.T.	Micrometri di profondità 0:100	90,00
R002.184	R.D.T.	Micrometri di profondità 0:200	125,00
R002.188	R.D.T.	Micrometri di profondità 0:300	160,00

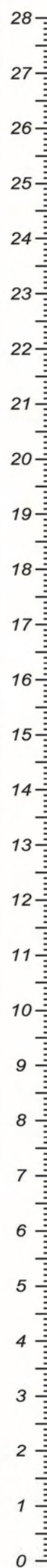

28
27
26
25
24
23
22
21
20
19
18
17
16
15
14
13
12
11
10
9
8
7
6
5
4
3
2
1
0

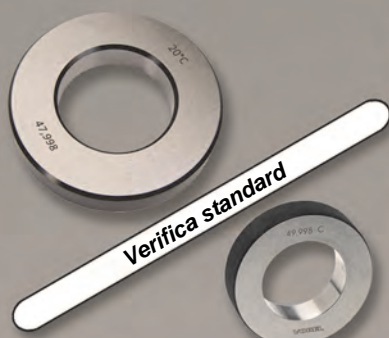

CS576.001	ACCREDIA ENTE ITALIANO DI ACCREDITAMENTO	Anelli lisci di azzeramento Ø5>150	61,00
CS576.005	ACCREDIA ENTE ITALIANO DI ACCREDITAMENTO	c/s quantità minima 5pz max 20pz cad.	richiesta
CS576.020	ACCREDIA ENTE ITALIANO DI ACCREDITAMENTO	c/s quantità superiore a 20pz	richiesta

Verifica standard - 1Ø sulla mezzeria (tot. 1)

RS576.015	R.D.T.	Anelli lisci di azzeramento Ø1,5>20	21,00
RS576.200	R.D.T.	Anelli lisci di azzeramento Ø20>50	25,00
RS576.500	R.D.T.	Anelli lisci di azzeramento Ø50>75	31,00
RS576.750	R.D.T.	Anelli lisci di azzeramento Ø75>100	36,00
RS577.000	R.D.T.	Anelli lisci di azzeramento Ø100>150	43,00
RS577.500	R.D.T.	Anelli lisci di azzeramento Ø150>200	52,00

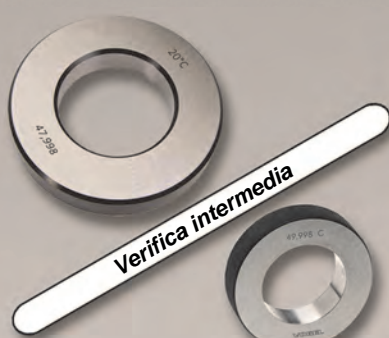

CI576.001	ACCREDIA ENTE ITALIANO DI ACCREDITAMENTO	Anelli lisci di azzeramento Ø5>150	81,00
CI576.005	ACCREDIA ENTE ITALIANO DI ACCREDITAMENTO	c/s quantità minima 5pz max 20pz cad.	richiesta
CI576.020	ACCREDIA ENTE ITALIANO DI ACCREDITAMENTO	c/s quantità superiore a 20pz	richiesta

Verifica intermedia - 3Ø a 3 altezze diverse (tot. 3)

RI576.015	R.D.T.	Anelli lisci di azzeramento Ø1,5>20	23,00
RI576.200	R.D.T.	Anelli lisci di azzeramento Ø20>50	27,00
RI576.500	R.D.T.	Anelli lisci di azzeramento Ø50>75	33,00
RI576.750	R.D.T.	Anelli lisci di azzeramento Ø75>100	39,00
RI577.000	R.D.T.	Anelli lisci di azzeramento Ø100>150	45,00
RI577.500	R.D.T.	Anelli lisci di azzeramento Ø150>200	54,00



CC576.001	ACCREDIA ENTE ITALIANO DI ACCREDITAMENTO	Anelli lisci di azzeramento Ø5>150	richiesta
-----------	---	------------------------------------	-----------

Verifica completa - 3Ø a 3 altezze diverse + ovalità 3Ø a 90° (tot. 6)

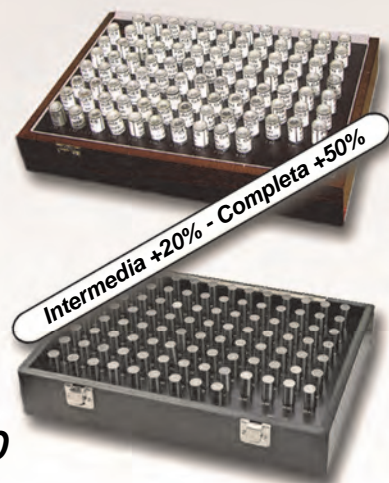

LAS-6001	ACCREDIA ENTE ITALIANO DI ACCREDITAMENTO	Supplemento obbligatorio serializzazione laser	2,45
C006.001	ACCREDIA ENTE ITALIANO DI ACCREDITAMENTO	Spine calibrate singole 1-4pz grado 1 o 2 cad.	54,00
C006.010	ACCREDIA ENTE ITALIANO DI ACCREDITAMENTO	Serie spine calibrate 10pz grado 1 o 2	97,00
C006.695	ACCREDIA ENTE ITALIANO DI ACCREDITAMENTO	Serie spine calibrate 20pz grado 1 o 2	155,00
C006.702	ACCREDIA ENTE ITALIANO DI ACCREDITAMENTO	Serie spine calibrate 100pz grado 1 o 2 Ø1-10	716,00
C006.717	ACCREDIA ENTE ITALIANO DI ACCREDITAMENTO	Serie spine calibrate 100pz grado 1 o 2 Ø11-20	725,00

Verifica standard (per verifica intermedia +20% - verifica completa +50%)

R006.001	R.D.T.	Spine calibrate singole 1-4pz grado 1 o 2 cad.	7,80
R006.010	R.D.T.	Serie spine calibrate 10pz grado 1 o 2	53,00
R006.695	R.D.T.	Serie spine calibrate 20pz grado 1 o 2	101,00
R006.702	R.D.T.	Serie spine calibrate 100pz grado 1 o 2 Ø1-10	312,00
R006.717	R.D.T.	Serie spine calibrate 100pz grado 1 o 2 Ø11-20	321,00



C005.032	ACCREDIA	Serie 32 blocchetti di riscontro gr.0-1-2 D1	216,00
C005.047	ACCREDIA	Serie 47 blocchetti di riscontro gr.0-1-2 D1	318,00
C005.087	ACCREDIA	Serie 87 blocchetti di riscontro gr.0-1-2 D1	594,00
C005.103	ACCREDIA	Serie 103 blocchetti di riscontro gr.0-1-2 D1	695,00

D1 Verifica in 1 punto centrale - D2 Verifica in 5 punti incl. variazione lunghezza



C555.032	ACCREDIA	Serie 32 blocchetti di riscontro gr.0-1-2 D2	262,00
C555.047	ACCREDIA	Serie 47 blocchetti di riscontro gr.0-1-2 D2	386,00
C555.087	ACCREDIA	Serie 87 blocchetti di riscontro gr.0-1-2 D2	714,00
C555.103	ACCREDIA	Serie 103 blocchetti di riscontro gr.0-1-2 D2	845,00

D1 Verifica in 1 punto centrale - D2 Verifica in 5 punti incl. variazione lunghezza



C500.000	ACCREDIA	Blocchetti singoli 0,5-100 1pz gr.0-1-2 D1	37,00
C500.003	ACCREDIA	Blocchetti singoli 0,5-100 3pz gr.0-1-2 D1	92,00
C500.005	ACCREDIA	Blocchetti singoli 0,5-100 5pz gr.0-1-2 D1	138,00
C500.006	ACCREDIA	Blocchetti singoli 0,5-100 6 pz (5+1) gr.0-1-2 D1	175,00

C555.000	ACCREDIA	Blocchetti singoli 0,5-100 1pz gr.0-1-2 D2	41,00
C555.003	ACCREDIA	Blocchetti singoli 0,5-100 3pz gr.0-1-2 D2	98,00
C555.005	ACCREDIA	Blocchetti singoli 0,5-100 5pz gr.0-1-2 D2	150,00
C555.006	ACCREDIA	Blocchetti singoli 0,5-100 6pz (5+1) gr.0-1-2 D2	191,00

D1 Verifica in 1 punto centrale - D2 Verifica in 5 punti incl. variazione lunghezza



C500.151	ACCREDIA	Blocchetti singoli 125-200 gr.0-1 D1	114,00
C500.154	ACCREDIA	Blocchetti singoli 225-300 gr.0-1 D1	121,00
C500.155	ACCREDIA	Blocchetti singoli 325-400 gr.0-1 D1	127,00
C500.158	ACCREDIA	Blocchetti singoli 425-650 gr.0-1 D1	134,00

C555.151	ACCREDIA	Blocchetti singoli 125-200 gr.0-1 D2	127,00
C555.154	ACCREDIA	Blocchetti singoli 225-300 gr.0-1 D2	138,00
C555.155	ACCREDIA	Blocchetti singoli 325-400 gr.0-1 D2	151,00
C555.158	ACCREDIA	Blocchetti singoli 425-650 gr.0-1 D2	157,00

D1 Verifica in 1 punto centrale - D2 Verifica in 5 punti incl. variazione lunghezza



C514.008	ACCREDIA	Serie 8 blocchetti 25-100 + 125-200 gr.0-1 D1	524,00
C513.008	ACCREDIA	Serie 8 blocchetti 125-500 gr.0-1 D1	640,00

C514.558	ACCREDIA	Serie 8 blocchetti 25-100 + 125-200 gr.0-1 D2	651,00
C513.558	ACCREDIA	Serie 8 blocchetti 125-500 gr.0-1 D2	794,00

D1 Verifica in 1 punto centrale - D2 Verifica in 5 punti incl. variazione lunghezza



C515.010	ACCREDIA	Serie 10pz contr.micrometri 0:25 - 2,5-25 gr.1 D1	85,00
C515.011	ACCREDIA	Serie 11pz contr.micrometri 0:25 - 1,4-25 gr.1 D1	93,50

C515.510	ACCREDIA	Serie 10pz contr.micrometri 0:25 - 2,5-25 gr.1 D2	99,00
C515.511	ACCREDIA	Serie 11pz contr.micrometri 0:25 - 1,4-25 gr.1 D2	109,00



C516.254	DAKKS	Serie 5pz contr.calibri (3 blocch. + 2 anelli) gr.1 D2	250,00
C516.256	DAKKS	Serie 6pz contr.calibri (4 blocch. + 2 anelli) gr.1 D2	395,00

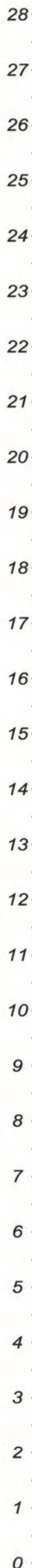

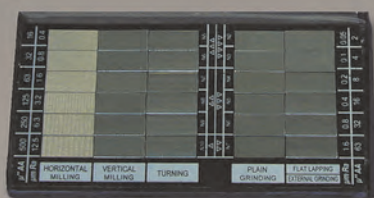

C935.001	ACCREDIA ENTE ITALIANO DI ACCREDITAMENTO	Campioni rugosità 1 area / 1 parametro	150,00
C935.002	ACCREDIA ENTE ITALIANO DI ACCREDITAMENTO	Campioni rugosità 2 aree / 1 parametro per area	191,00
C935.003	ACCREDIA ENTE ITALIANO DI ACCREDITAMENTO	Campioni rugosità 3 aree / 1 parametro per area	228,00
R935.001	R.D.T.	Campioni rugosità 1 area / 1 parametro	119,00
R935.002	R.D.T.	Campioni rugosità 2 aree / 1 parametro per area	156,00
R935.003	R.D.T.	Campioni rugosità 3 aree / 1 parametro per area	219,00



R906.601	R.D.T.	Campioni di durezza scale Rockwell	90,00
R906.605	R.D.T.	Campioni di durezza scale Brinell	90,00
R906.607	R.D.T.	Campioni di durezza scale Vickers oltre 1kg	90,00
R009.600	R.D.T.	Campioni di durezza scale Shore A-D	90,00



C701.714	ACCREDIA ENTE ITALIANO DI ACCREDITAMENTO	Comparatori o tastatori a leva analogici/digitali	92,00
R701.714	R.D.T.	Comparatori o tastatori a leva analogici/digitali	33,00



C897.X01	ACCREDIA ENTE ITALIANO DI ACCREDITAMENTO	Sfere calibrate singole fino a 100	58,00
R897.X01	R.D.T.	Sfere calibrate singole fino a 100	50,00



C724.501	ACCREDIA ENTE ITALIANO DI ACCREDITAMENTO	Spessimetri con comparatore analogico/digitale	92,00
R724.501	R.D.T.	Spessimetri con comparatore analogico/digitale	68,00



C406.108	ACCREDIA ENTE ITALIANO DI ACCREDITAMENTO	Assortimenti spessimetri a 8 lame L100	85,00
C406.113	ACCREDIA ENTE ITALIANO DI ACCREDITAMENTO	Assortimenti spessimetri a 13 lame L100	109,00
C406.120	ACCREDIA ENTE ITALIANO DI ACCREDITAMENTO	Assortimenti spessimetri a 20 lame L100	132,00
R406.108	R.D.T.	Assortimenti spessimetri a 8 lame L100	39,00
R406.113	R.D.T.	Assortimenti spessimetri a 13 lame L100	51,00
R406.120	R.D.T.	Assortimenti spessimetri a 20 lame L100	62,00



C915.001	ACCREDIA ENTE ITALIANO DI ACCREDITAMENTO	Spessori calibrati singoli	52,00
R915.001	R.D.T.	Spessori calibrati singoli	32,00



R963.X01	R.D.T.	Termometri con sonde K 30/1000°C su 1 punto	38,00
R963.X02	R.D.T.	Termometri con sonde K 30/1000°C su 2 punti	76,00
R963.X03	R.D.T.	Termometri con sonde K 30/1000°C su 3 punti	113,00
R963.X00	R.D.T.	Ogni punto supplementare ai 5 punti cad.	26,00
R963.002	R.D.T.	Ogni sonda agg. alla prima tarata a pari condizioni	65,00

R960.X01	R.D.T.	Termometri a infrarossi 20/300°C su 1 punto	55,00
R960.X02	R.D.T.	Termometri a infrarossi 20/300°C su 2 punti	113,00
R960.X03	R.D.T.	Termometri a infrarossi 20/300°C su 3 punti	169,00
R960.X00	R.D.T.	Ogni punto supplementare ai 5 punti cad.	39,00

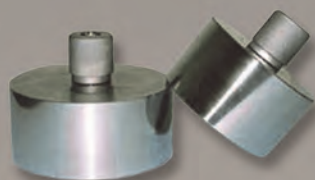

R567.002	R.D.T.	Tamponi di azzeramento (master) fino a Ø50	16,00
R567.050	R.D.T.	Tamponi di azzeramento (master) da Ø50 a 75	23,00
R567.075	R.D.T.	Tamponi di azzeramento (master) da Ø50 a 100	28,00
R567.100	R.D.T.	Tamponi di azzeramento (master) da Ø100 a 150	35,00
R567.150	R.D.T.	Tamponi di azzeramento (master) da Ø150 a 200	44,00
R567.200	R.D.T.	Tamponi di azzeramento (master) da Ø200 a 250	54,00

Verifica standard di 1Ø in corrispondenza della linea di fede sulla mezzeria



R568.002	R.D.T.	Tamponi P oppure NP lisci fino a Ø50 cad.	18,00
R568.050	R.D.T.	Tamponi P oppure NP lisci da Ø50 a 75 cad.	25,00
R568.075	R.D.T.	Tamponi P oppure NP lisci da Ø75 a 100 cad.	33,00
R568.100	R.D.T.	Tamponi P oppure NP lisci da Ø100 a 150 cad.	39,00
R568.150	R.D.T.	Tamponi P oppure NP lisci da Ø150 a 200 cad.	48,00
R568.200	R.D.T.	Tamponi P oppure NP lisci da Ø200 a 250 cad.	58,00

Verifica intermedia di 3Ø a 3 altezze diverse (3 totali)



R575.023	R.D.T.	Tamponi lisci P/NP fino a Ø50 cad.	20,00
R575.503	R.D.T.	Tamponi lisci P/NP da Ø50 a 75 cad.	27,00
R575.753	R.D.T.	Tamponi lisci P/NP da Ø75 a 100 cad.	35,00
R576.003	R.D.T.	Tamponi lisci P/NP da Ø100 a 150 cad.	42,00
R576.503	R.D.T.	Tamponi lisci P/NP da Ø150 a 200 cad.	52,00
R577.003	R.D.T.	Tamponi lisci P/NP da Ø200 a 250 cad.	64,00

Verifica intermedia di 3Ø a 3 altezze diverse (6 misure totali)



C575.061	ACCREDIA	Tamponi lisci P/NP singoli	richiesta
C575.06X	R.D.T.	Come sopra oltre 5pz fino a 10pz ed oltre 10pz	richiesta

Verifica completa di 3Ø a 3 altezze diverse + ovalità 3Ø a 90° (12 totali)



C569.002	ACCREDIA	Anelli filettati da Ø5 a Ø120 cad.	81,00
R569.003	R.D.T.	Anelli filettati da Ø3 a Ø20 cad.	18,00
R569.020	R.D.T.	Anelli filettati da Ø20 a Ø50 cad.	23,00
R569.050	R.D.T.	Anelli filettati da Ø50 a Ø75 cad.	30,00
R569.075	R.D.T.	Anelli filettati da Ø75 a Ø150 cad.	34,00



C572.002	ACCREDIA	Tamponi filettati P/NP da Ø5 a Ø120 cad.	81,00
R572.003	R.D.T.	Tamponi filettati P/NP da Ø3 a Ø20 cad.	26,00
R572.020	R.D.T.	Tamponi filettati P/NP da Ø20 a Ø50 cad.	30,00
R572.050	R.D.T.	Tamponi filettati P/NP da Ø50 a Ø75 cad.	34,00
R572.075	R.D.T.	Tamponi filettati P/NP da Ø75 a Ø150 cad.	41,00



C009.648	ACCREDIA	Preset altezza 50/100 contatto 1 punto centrale	138,00
R009.648	R.D.T.	Preset altezza 50/100 contatto 1 punto centrale	59,00



R003.066	R.D.T.	Goniometri e rapportatori d'angolo con 1 asta	99,00
R003.995	R.D.T.	Goniometri e rapport. d'angolo digit. con 1 asta	107,00

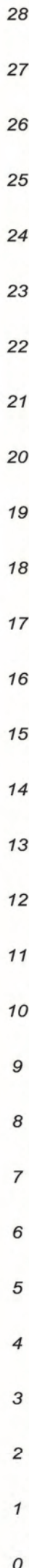

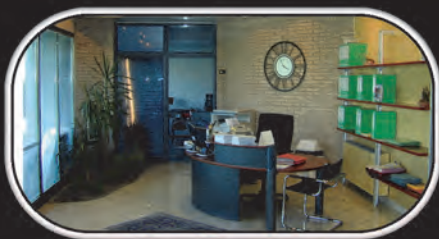

VOGEL



**POSSIBILITA' DI
PERSONALIZZARE
QUASI TUTTI GLI
ARTICOLI CON IL
NOSTRO NUOVO
SERVIZIO LASER**

VOGEL srl
Via A.Vespucci, 3/5
25024 LENO (BS)

CF e P.IVA
01594040980

Tel 030 906591 - 8 linee r.a.
Fax 030 9067763
WhatsApp 392 7755222
Web www.vogel.it
Mail info@vogel.it

Social: VOGEL SRL

Questa Vi è stata presentata da: