



www.gerardi.it

N°1
2021

OFFERTA SPECIALE



4% di Risparmio!

Cubo a Reticolo con 4 Morse FMS



8% di Risparmio!

Cubo Portapezzi con 8 Unità Zero Point
& 4 Morse Morse Standard



6% di Risparmio!

Cubo a Reticolo con 8 Morse Multitasking



10% di Risparmio!

Cubo Portapezzi con 16 Unità Zero Point
& 8 Morse Multiflex

EXPIRES ON JULY 2021

Dotazione standard: 1 Chiave a pipa, 1 Perno calibrato o firante Z.P.
 2 tasselli di posizionamento e 2 tasselli per regolazione autocentrante

COMPRESO: Coppia inserti G01 + Arresto laterale magnetico Art. 370EM

Art.650

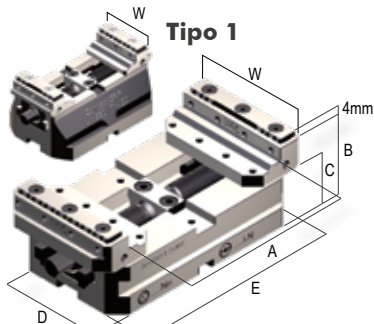

Tipo	1 - 12kN			2 - 22kN				3 - 32kN				
Larghezza ganascia W	50			88				123				
Apertura massima A	54	94	134	96	136	176	216	133	183	233	283	333
Altezza morsa B	65			65				89				
Altezza corpo C	45			38				57				
Larghezza base D	79,9			89,9				124,9				
Lunghezza base E	80	120	160	120	160	200	240	160	210	260	310	360
Kg	1,9	2,7	3,4	3,6	4,4	5,2	5,8	9,1	10,9	12,8	14,8	17
Cod.	7.65.01080	7.65.01120	7.65.01160	7.65.02120	7.65.02160	7.65.02200	7.65.02240	7.65.03160	7.65.03210	7.65.03260	7.65.03310	7.65.03360
PREZZO LISTINO €	684	789	894	841	946	1.051	1.156	1.366	1.576	1.787	2.102	2.312
PREZZO OFFERTA €	599	699	799	699	799	899	999	1.199	1.299	1.499	1.799	1.999

Inserti GRIP specifici per qualsiasi tipo di materiale o durezza

Art.650X Fissa centrale Per trasformare la morsa in doppia	Art.650S Liscia+Ruvida Materiali teneri e lavorazioni finali	Art.650T G01 Grip passo 1,5mm Materiali di durezza normale	Art.650T G02 Grip passo 2mm Materiali di notevole durezza	Art.650T G11 Grip passo 11mm Materiali teneri	Art.650R Codà di rondine Serraggio irreversibile ad incastro
---	---	---	--	--	---

Art.651H

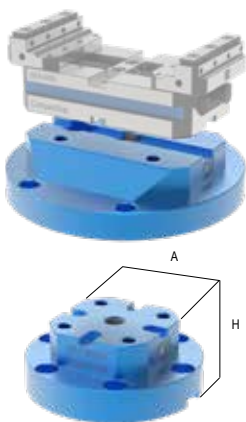

H	Tipo	1			2				3				
	Ingombro base A	80	120	160	120	160	200	240	160	210	260	310	360
50	Cod.	7.65.1H1080 /050	7.65.1H1120 /050	7.65.1H1160 /050	7.65.1H2120 /050	7.65.1H2160 /050	7.65.1H2200 /050	7.65.1H2240 /050	7.65.1H3160 /050	7.65.1H3210 /050	7.65.1H3260 /050	7.65.1H3310 /050	7.65.1H3360 /050
	PREZZO LISTINO €	363	432	516	516	516	516	639	599	599	921	955	1.104
	PREZZO OFFERTA €	300	350	400	400	400	400	500	500	500	750	750	900
75	Cod.	7.65.1H1080 /075	7.65.1H1120 /075	7.65.1H1160 /075	7.65.1H2120 /075	7.65.1H2160 /075	7.65.1H2200 /075	7.65.1H2240 /075	7.65.1H3160 /075	7.65.1H3210 /075	7.65.1H3260 /075	7.65.1H3310 /075	7.65.1H3360 /075
	PREZZO LISTINO €	373	453	545	545	545	545	680	638	638	973	1.008	1.167
	PREZZO OFFERTA €	300	350	450	450	450	450	550	500	500	800	800	950
100	Cod.	7.65.1H1080 /100	7.65.1H1120 /100	7.65.1H1160 /100	7.65.1H2120 /100	7.65.1H2160 /100	7.65.1H2200 /100	7.65.1H2240 /100	7.65.1H3160 /100	7.65.1H3210 /100	7.65.1H3260 /100	7.65.1H3310 /100	7.65.1H3360 /100
	PREZZO LISTINO €	384	474	575	575	575	575	722	676	676	1.028	1.062	1.231
	PREZZO OFFERTA €	300	400	450	450	450	450	600	550	550	800	900	1.000

Supporto piramidale specifico per centri di lavoro a 5 assi - DISPONIBILE a 4 posizioni

Art.643H

Supporto piramidale in alluminio, consente di montare contemporaneamente 3 morse CompactGrip inclinate di 45° o 60° incrementando così lo spazio di lavoro e permettendo lavorazioni anche di più particolari anche in punti normalmente difficili da raggiungere.

Art.643H

Disponibile anche supporto piramidale in alluminio a 4 posizioni, consente di montare contemporaneamente 4 morse CompactGrip 3 inclinate di 45° ed una in orizzontale sul piano superiore della piramide.

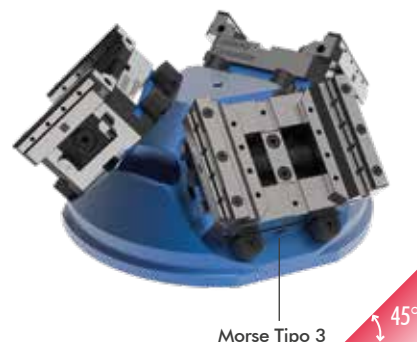

Kit di fissaggio del supporto piramidale NON INCLUSO

Art.660

Tavola cambio rapido rettangolare

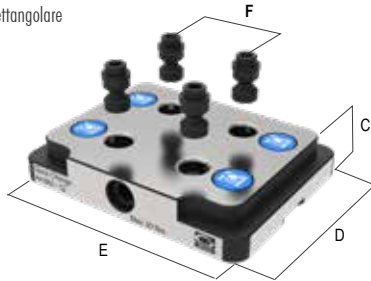

Dotazione standard: 4 Tiranti Art.660B

Tipo	1-2	3
F	52	96
C	27	27
D	116	156
E	150	190
kg	3	5,2
Cod.	9.66.05200	9.66.09600
PREZZO LISTINO €	693	998
PREZZO OFFERTA €	599	899

Art.661

Tavola cambio rapido tonda

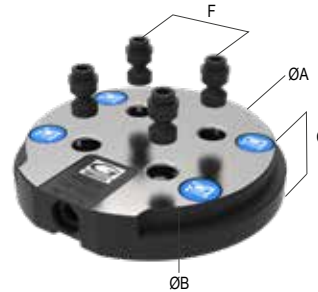

Dotazione standard: 4 Tiranti Art.660B

Tipo	1-2	3
F	52	96
ØA	156	196
ØB	120	175
C	27	27
kg	3	5,2
Cod.	9.66.15200	9.66.19600
PREZZO LISTINO €	663	969
PREZZO OFFERTA €	599	899

Art.660S

Tavola cambio rapido rettangolare temprata con parte lavorabile senza fori

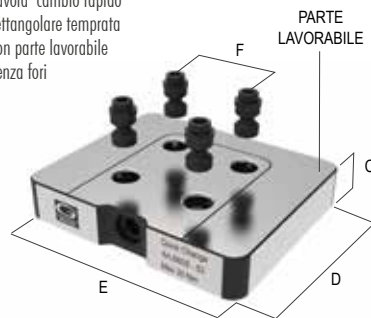

Dotazione standard: 4 Tiranti Art.660B

Tipo	1-2	3
F	52	96
C	27	27
D	126	156
E	150	190
kg	3	5,2
Cod.	9.66.05520	9.66.05960
PREZZO LISTINO €	561	765
PREZZO OFFERTA €	499	699

Personalizzazione esclusa

Art.661S

Tavola cambio rapido tonda temprata con parte lavorabile senza fori



Dotazione standard: 4 Tiranti Art.660B

Tipo	1-2	3
F	52	96
ØA	158	196
C	27	27
kg	3,8	-
Cod.	9.66.15520	9.66.15960
PREZZO LISTINO €	612	1.020
PREZZO OFFERTA €	499	699

Personalizzazione esclusa

Art.660R

Riduzione rettangolare

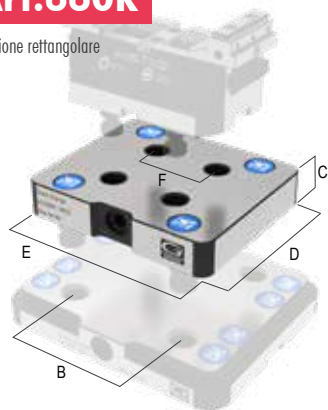

Dotazione standard: 4 Tiranti Art.660B

F	Da 96 a 52
B	96
C	27
D	126
E	150
kg	3,75
Cod.	9.66.0R210
PREZZO LISTINO €	612
PREZZO OFFERTA €	499

Art.661R

Riduzione tonda

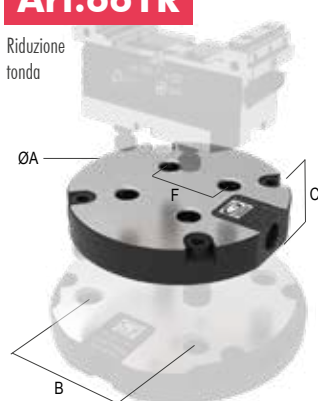

Dotazione standard: 4 Tiranti Art.660B

F	Da 96 a 52
ØA	158
B	96
C	27
kg	3,75
Cod.	9.66.1R210
PREZZO LISTINO €	765
PREZZO OFFERTA €	499

Art.660B

Tiranti per tavola a cambio rapido



Art.661S

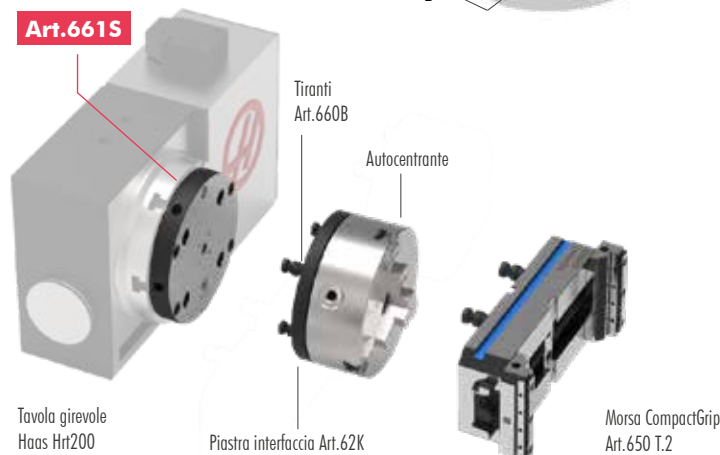

Art.661S

Tavola cambio rapido Art.661S
ESEMPIO di montaggio tavola a cambio rapido tonda per morse CompactGrip



STANDARD FLEX

Geniale sistema a pettine per la rapida sostituzione delle piastre ganasce discendenti
IDEALE PER CENTRI VERTICALI

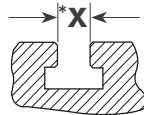

5 ANNI DI GARANZIA

RISPARMI FINO AL

23%

* Da comunicare in fase d'ordine

Morsa modulare di precisione serie StandardFLEX +

COMPRESO :



n. 4 staffe Art. 298 + n.4 dadi a "T" Art.287



Art.1A

Tipo	2 - 25kN		3 - 30kN		4 - 30kN			5 - 40kN		
Apertura massima A	150	200	300	200	300	400	200	300	400	
Larghezza ganasce W	121 mm	146 mm		171 mm			196 mm			
Altezza ganasce B	38	48		58			63			
Lunghezza base D	345	420	520	455	555	655	495	595	695	
Cod.	1.1A.20000	1.1A.32000	1.1A.33000	1.1A.42000	1.1A.43000	1.1A.44000	1.1A.52000	1.1A.53000	1.1A.54000	
PREZZO LISTINO €	814	979	1.129	1.245	1.369	1.494	1.626	1.947	2.274	
PREZZO OFFERTA €	715	769	869	1.050	1.120	1.230	1.430	1.690	1.890	

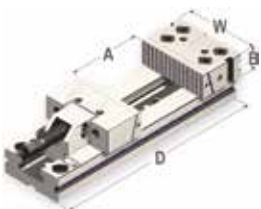

Art.230B dolce

Art.230C

Art.230E a Gradino

Art.230F prismatica

Art.138 a squadra sovrapponibile

Art.150 prismatica sovrapponibile

Art.212 mobile intermedia con doppio gradino

Art.257 gruppo di serraggio a vite idraulica

* RISPARMI IL

20%

* Solo se acquistate con la morsa

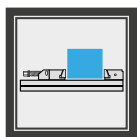

XL

Morsa con la base molto più lunga delle normali morsa Standard
IDEALE PER CENTRI VERTICALI

5 ANNI DI GARANZIA

RISPARMI FINO AL

26%

Morsa serie XL con dotazione standard +

COMPRESO :



n. 6 staffe Art. 298 + n.6 dadi a "T" Art.287



Art.21

(Serraggio Singolo)

Tipo	2 - 25kN		3 - 30kN		4 - 30kN		
Apertura massima A	320	360	460	500	600	700	
Larghezza ganasce W	125 mm	150 mm		175mm			
Altezza ganasce B	40	50		60			
Lunghezza base D	520	580	680	766	866	966	
Cod.	2.21.23200	2.21.33600	2.21.34600	2.21.45000	2.21.46000	2.21.47000	
kg	17	32	35	52	56	61	
PREZZO LISTINO €	1.009	1.254	1.390	1.609	1.752	1.901	
PREZZO OFFERTA €	750	950	1.100	1.300	1.400	1.500	

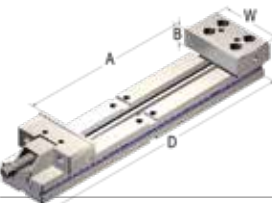

LE PIÙ VENDUTE



Art.138 A squadra sovrapponibile

Art.150 Prismatica sovrapponibile

Art.217 Mobile Prismatica

Art.313 Piastre magnetiche parallele piane

Art.2305 Piastra ganasca quadrettata

* RISPARMI IL

20%

* Solo se acquistate con la morsa

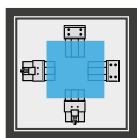

PROLUNGHE MODULARI

Elemento di prolunga (lato ganasca mobile) per morsa Art.1 - Art.1A
IDEALE PER CENTRI VERTICALI

COMPRESO :



n. 4 staffe Art. 298 + n.2 tasselli Art.297



Art.51

Tipo	2	3	4	5
Lunghezza base D	160	230	240	300
Cod.	1.80.23160	1.80.33230	1.80.43250	1.80.53300
kg	3,4	8,2	11,5	20
PREZZO LISTINO €	174	236	275	439

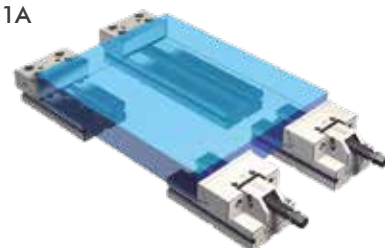

Art.1/1A +

Art.51



Tutti i componenti sono in acciaio cementato, temprato rettificato



KIT AUTOMAZIONE

Centraline con comando pneumatico e cilindro a singolo effetto

IDEALE PER CENTRI VERTICALI

PER MORSE Art.1 e Art.1A

5 ANNI DI GARANZIA

RISPARMI FINO AL

13%

MADE IN ITALY

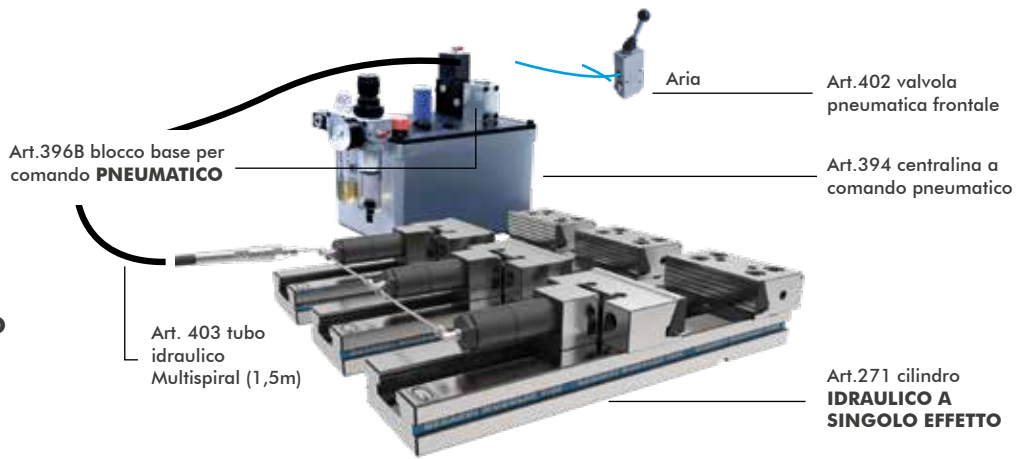
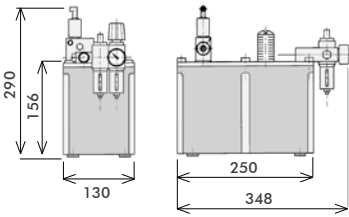

N.B. Sono **DISPONIBILI** centraline con elettrovalvole per **PER CNC**

Art.392

N°1 SERRAGGIO MORSA NON INCLUSO

Tipo	2	3	4	5
Cod.	4.39.22000	4.39.23000	4.39.24000	4.39.25000
LISTINO €	1.529	1.539	1.566	1.722
OFFERTA €	1.399	1.399	1.399	1.499

KIT di serraggio SIMULTANEO di più morse

*Art.405H (Non compreso)

Tubo in acciaio zincato Ø6 (m1,0) Codice: 4.40.5H000

Art.392/2

(Art.271- 394 - 402 - 403)

N°2 SERRAGGI SIMULTANEI

Art.392 + N°1 Art.271

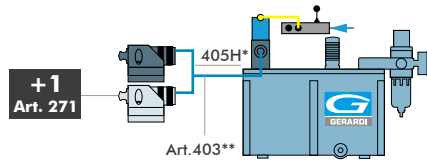

Tipo	2	3	4	5
Cod.	4.39.22002	4.39.23002	4.39.24002	4.39.25002
PREZZO LISTINO €	1.841	1.860	1.915	2.226
PREZZO OFFERTA €	1.699	1.699	1.699	1.999

Art.392/3

N°3 SERRAGGI SIMULTANEI

Art.392 + N°2 Art.271

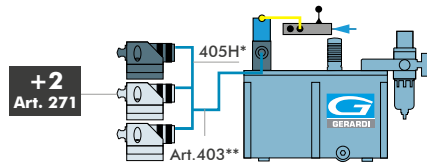

Tipo	2	3	4	5
Cod.	4.39.22003	4.39.23003	4.39.24003	4.39.25003
PREZZO LISTINO €	2.152	2.179	2.261	2.729
PREZZO OFFERTA €	1.999	1.999	1.999	2.399

Art.392/4

N°4 SERRAGGI SIMULTANEI

Art.392 + N°3 Art.271

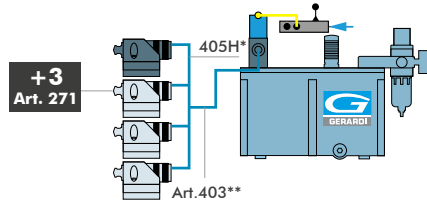

Tipo	2	3	4	5
Cod.	4.39.22004	4.39.23004	4.39.24004	4.39.25004
PREZZO LISTINO €	2.465	2.499	2.611	3.234
PREZZO OFFERTA €	2.299	2.299	2.299	2.899

KIT di serraggio INDIPENDENTE di più morse

**Art.403 (compreso)

Tubo idraulico Multispiral 760bar completo di attacco rapido Art. 270A (m 1,5) Codice: 4.40.30000

Art.392A/2

(Art.271- 394 - 402 - 403)

N°2 SERRAGGI INDIPENDENTI

Art.392 + N°1 Art.407B

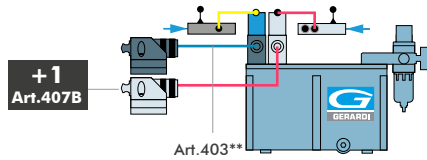

Tipo	2	3	4	5
Cod.	4.39.2A202	4.39.2A302	4.39.2A402	4.39.2A502
PREZZO LISTINO €	2.502	2.519	2.582	2.974
PREZZO OFFERTA €	2.299	2.299	2.299	2.699

Art.392A/3

N°3 SERRAGGI INDIPENDENTI

Art.392 + N°2 Art.407B

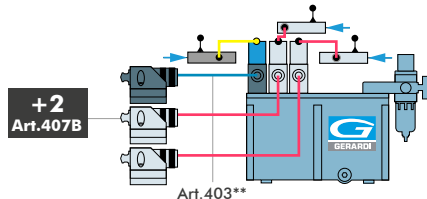

Tipo	2	3	4	5
Cod.	4.39.2A203	4.39.2A303	4.39.2A403	4.39.2A503
PREZZO LISTINO €	2.912	2.938	3.019	3.470
PREZZO OFFERTA €	2.699	2.699	2.699	3.099

Art.392A/4

N°4 SERRAGGI INDIPENDENTI

Art.392 + N°3 Art.407B

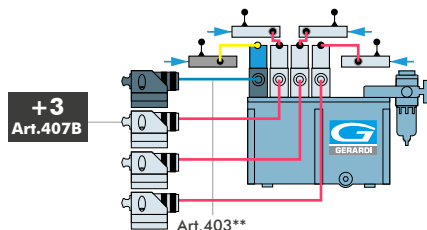

Tipo	2	3	4	5
Cod.	4.39.2A204	4.39.2A304	4.39.2A404	4.39.2A504
PREZZO LISTINO €	3.605	3.640	3.745	4.346
PREZZO OFFERTA €	3.399	3.399	3.399	3.399



Serraggio controllato e costante

Art.864 Morsa doppia singola autocentrante con ganasce a doppio gradino zigrinate.

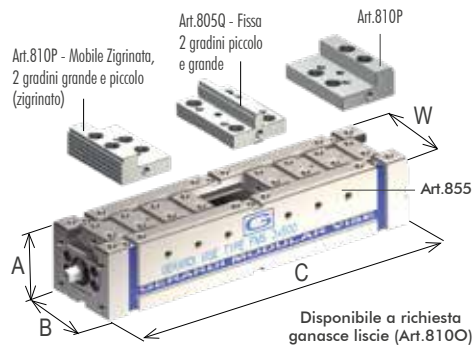

Dot. standard: 1 Chiave a pipa, 2 tasselli di posizionamento, 1 piastrina di collegamento slitte morsa Art.801S e 2 arresti laterali +

COMPRESO : n. 4 staffe Art. 298

Tipo W	2 (94mm) - 25kN			3 (124mm) - 30kN		4 (144mm) - 30kN
Altezza base A	90	90	90	100	100	120
Larghezza base B	95	95	95	125	125	145
Lunghezza base C	400	500	600	500	600	600
Cod.	5.86.42400	5.86.42500	5.86.42600	5.86.43500	5.86.43600	5.86.44600
PREZZO LISTINO € Morsa Completa Art.864	1.847	2.273	2.443	2.261	2.858	2.862
PREZZO OFFERTA € Morsa Completa Art.864	1.649	2.049	2.199	2.099	2.549	2.599

CON L'ACQUISTO DELLA MORSA ART.864 A SCELTA UNA GANASCIA CON RISPARMIO DEL 20%

Art.810P + **Art.805G**

Cod.	5.81.00200	5.81.00300	5.81.00400
P. LISTINO €	194	212	263
P. OFFERTA €	152	166	206

Art.8100
Ganascia mobile con gradino piccolo e grande

Cod.	5.80.5F200	5.80.5F300	5.80.5F400
P. LISTINO €	190	211	262
P. OFFERTA €	149	165	205

Art.805F
Ganascia fissa con doppio gradino 3x5 liscia

Cod.	5.81.0X200	5.81.0X300	5.81.0X400
P. LISTINO €	293	332	372
P. OFFERTA €	230	260	291

Art.810X
Ganascia mobile oscillante con gradino piccolo e grande

Art.810P + **Art.805G**

Cod.	5.80.5B200	5.80.5B300	5.80.5B400
P. LISTINO €	129	145	199
P. OFFERTA €	101	114	156

Art.805B
Ganascia fissa dolce

Cod.	5.80.5G200	5.80.5G300	5.80.5G400
P. LISTINO €	190	211	262
P. OFFERTA €	149	165	205

Art.805G
Ganascia fissa con doppio gradino 3x5 zigrinata

Cod.	5.80.5I200	5.80.5I300	5.80.5I400
P. LISTINO €	190	211	262
P. OFFERTA €	149	165	205

Art.805I
Ganascia fissa con doppio prisma verticale

Art.868

Morsa autocentrante (opzione doppia o singola) con ganasce alte.

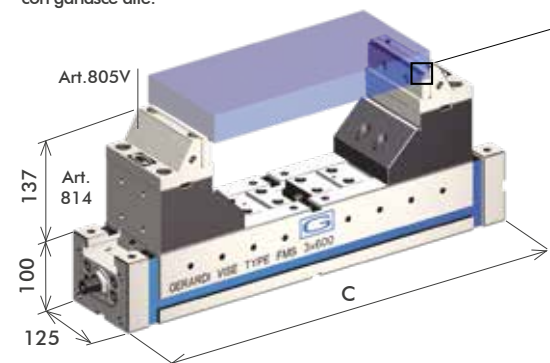

Art.247T GRIP

MORSA FMS con GANASCE ALTE

Possibilità di utilizzo di qualsiasi ganascia fissa FMS anziché del corpo ganascia 805V
Possibilità di due posizioni per ciascuna ganascia fissa e per base ganascia mobile Art.814

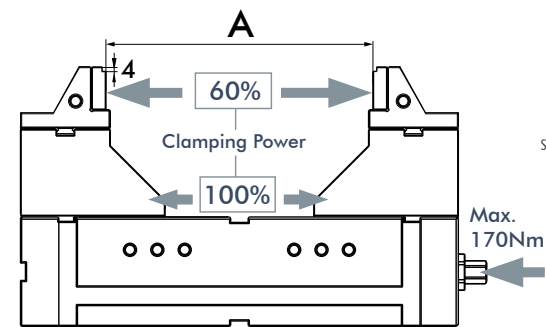
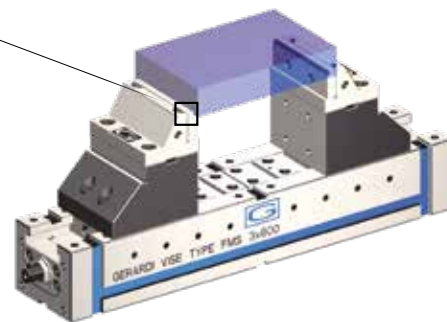

Dot. Std.: 1 Chiave a pipa, 1 piastrina di collegamento slitte morsa Art.801S, 2 tasselli di posizionamento e 1 arresto laterale +

COMPRESO : n. 4 staffe Art. 298

Tipo (W)	3 (124mm) - 30kN	
Apertura Massima A	344	444
Lunghezza base C	500	600
Cod.	5.86.83500	5.86.83600
PREZZO LISTINO €	2.281	2.859

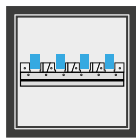

MULTIFLEX

Per serraggi multipli da 1 fino a 19 pezzi anche di diverse dimensioni

IDEALE PER CENTRI VERTICALI E ORIZZONTALI

5 ANNI DI GARANZIA

RISPARMI FINO AL

34%

Art.600

Art.600W

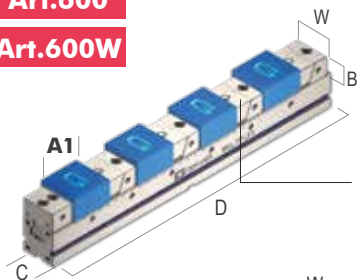

Art.605
Ganascia fissa e mobile

Art.606

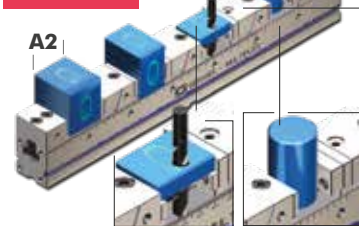

Art.609
Ganascia fissa e mobile a gradino integrale

Ogni morsa è predisposta per il serraggio di 4 pezzi
Dot. standard: Chiave a "T", 2 tasselli di posizionamento e 4 arresti laterali +

COMPRESO :



n. 6 staffe Art. 298

Tipo	Art.600 / Art.600W							Art.606				
	mm	B	C ⁺⁰ / _{-0,02}	D	W	A1mm	Cod.	PREZZO LISTINO €	PREZZO OFFERTA €	A2mm	Cod.	PREZZO LISTINO €
1 20kN	32/25	50	300	49	4x8	6.60.01300	1.059	699	3x19	6.60.61300	1.604	1.150
	32/25	50	400	49	4x33	6.60.01400	1.151	799	4x23	6.60.61400	1.671	1.250
	32/25	50	500	49	4x58	6.60.01500	1.254	899	4x48	6.60.61500	1.773	1.350
	32/25	50	600	49	4x83	6.60.01600	1.367	999	4x73	6.60.61600	1.886	1.450
	32/25	50	700	49	4x108	6.60.01700	1.529	1.099	4x97	6.60.61700	2.050	1.550
2 30kN NEW	40	75	400	74	4x12	6.60.02400	1.379	1.019	3x28	6.60.62400	1.997	1.450
	40	75	500	74	4x37	6.60.02500	1.481	1.149	4x24	6.60.62500	2.101	1.550
	40	75	600	74	4x62	6.60.02600	1.595	1.249	4x49	6.60.62600	2.217	1.650
	40	75	700	74	4x87	6.60.02700	1.708	1.349	4x74	6.60.62700	2.331	1.750
	40	75	800	74	4x112	6.60.02800	1.862	1.449	4x99	6.60.62800	2.495	1.850
	40	75	900	74	4x137	6.60.02900	2.027	1.649	4x124	6.60.62900	2.661	1.950
3 40kN	60	100	700	99	4x59	6.60.03700	1.976	1.549	4x44	6.60.63700	2.693	2.050
	60	100	800	99	4x84	6.60.03800	2.139	1.649	4x69	6.60.63800	2.858	2.150
	60	100	900	99	4x109	6.60.03900	2.306	1.849	4x94	6.60.63900	3.023	2.350
	60	100	1000	99	4x134	6.60.03100	2.527	2.049	4x119	6.60.63100	3.244	2.550

OFFERTA PIASTRE PARALLELE MAGNETICHE E RIPORTATE:

Art.138
Coppia di piastre parallele magnetiche piane per Art.600

* RISPARMI IL

40%

* Solo se acquistate con la morsa



ESEMPIO:

Art.600 2x600 con 4 coppie di piastre parallele magnetiche
€ 1.249 + € 136 anzichè € 228

Art.610E
Piastra parallela riportata per Art.606

* RISPARMI IL

25%

* Solo se acquistate con la morsa

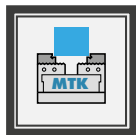

MULTITASKING

Morse autocentranti o eccentriche

Ideali per centri di lavoro a 5 assi

IDEALE PER CENTRI A 5 ASSI

5 ANNI DI GARANZIA

* RISPARMI FINO AL

47%

Art.640

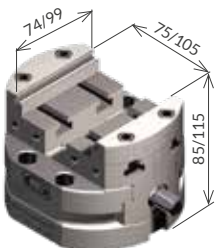

Dot. Standard : 1 arresto laterale, 1 chiave a pipa, 1 coppia di tasselli di orientamento Art.297, 1 perno di centraggio Art.640P e 2 ganasce Art.645T +

COMPRESO: n.2 ganasce Art. 645T

Tipo	1	2
Cod.	6.64.01000	6.64.02000
PREZZO LISTINO €	224 + 1.636	254 + 2.012
PREZZO OFFERTA €	999	1.199

Art.641H



Rialzo Semplice per morsa Art.640

Tipo	1	2
Cod.	7.64.1H100AL/100	7.64.1H200AL/100
PREZZO LISTINO €	575	676
PREZZO OFFERTA €	379	399

Art.63

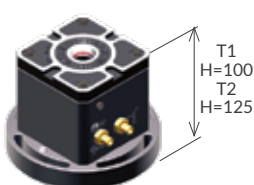

Rialzo con zero point per morsa Art.640 per cambio rapido

Dot Standard : 1 tirante Art.10S/ 11S 1 tappo teflon con O-ring Art.9 - 1 perno di centraggio Art.640P, -1 spina di orientamento Art.79

Tipo	1	2
Cod.	9.63.10000	9.63.20000
PREZZO LISTINO €	1.087	1.819
PREZZO OFFERTA €	899	1.399

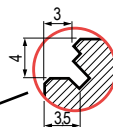

Art.645B
Ganascia Dolce

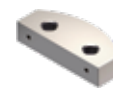

Art.645C
Ganascia Liscia

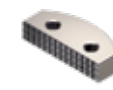

Art.645D
Ganascia zigrinata

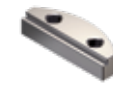

Art.645E
Ganascia a gradino



Art.645F
Ganascia prismatica



Art.645T
Ganascia Grip
IN DOTAZIONE

Tipo	1	2
Cod.	6.64.5B100	6.64.5B200
P. LISTINO €	89	106
P. OFFERTA €	67	80
Cod.	6.64.5C100	6.64.5C200
P. LISTINO €	89	106
P. OFFERTA €	67	80
Cod.	6.64.5D100	6.64.5D200
P. LISTINO €	89	106
P. OFFERTA €	67	80
Cod.	6.64.5E100	6.64.5E200
P. LISTINO €	100	117
P. OFFERTA €	76	88
Cod.	6.64.5F100	6.64.5F200
P. LISTINO €	112	127
P. OFFERTA €	84	96
Cod.	6.64.5T100	6.64.5T200
P. LISTINO €	112	127
P. OFFERTA €	84	96

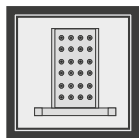

CUBI PORTAPEZZI

Fusioni in ghisa monoblocco sgrassata con doppio trattamento di distensione
IDEALE PER CENTRI ORIZZONTALI

NEW

**NUOVI MODELLI
 IN OFFERTA !**

5 ANNI DI GARANZIA

RISPARMI FINO AL

25%

MADE IN ITALY

Art.53B

5th faccia lavorabile

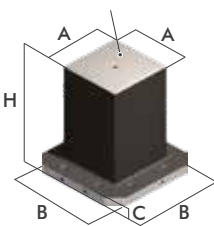

Cod.	A	B	C	D	H	kg	LISTINO €	OFFERTA €
8.53.B00080	260	400	45	-	550	197	1.616	1.400
8.53.B00081	260	400	45	-	660	228	1.866	1.540
8.53.B00100	260	500	45	-	650	255	2.108	1.800
*8.53.B00105	260	500	45	-	750	284	2.185	1.800
8.53.B00115	310	500	45	-	900	383	3.098	2.500
8.53.B00171	360	500	45	-	700	356	2.903	2.300
8.53.B00180	360	630	45	-	820	452	3.679	3.000
8.53.B00211	510	630	45	-	860	61	5.111	3.350

* Solo per pallet a cave a "T"

Art.55B

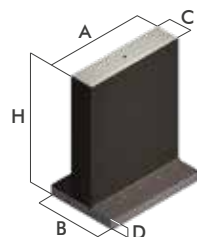

Cod.	A	B	C	D	H	kg	LISTINO €	OFFERTA €
8.55.B00052	400	400	160	50	660	244	2.045	1.600
8.55.B00053	500	500	160	50	700	331	2.731	2.100
8.55.B00054	500	500	210	55	600	316	2.654	2.100
8.55.B00170	630	450	160	55	820	460	3.793	3.000
8.55.B00172	630	630	210	55	850	545	4.518	3.340
8.55.B00190	800	450	160	65	800	604	5.065	3.840

Art.57B

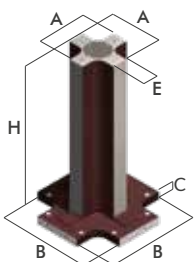

Cod.	A	B	C	E	H	kg	LISTINO €	OFFERTA €
8.57.B00100	203	500	40	80	750	157	1.370	1.300
8.57.B00110	273	500	40	80	850	235	1.819	1.600
8.57.B00120	233	500	40	110	850	218	1.754	1.500
8.57.B00130	303	500	40	150	850	269	2.110	1.750
8.57.B00140	303	630	40	150	950	327	2.388	2.050

Art.53B2 PLUS

Cod.	kg	LISTINO €	OFFERTA €
8.53.B20080	182	2.061	1.750
8.53.B20081	204	2.339	1.900
8.53.B20100	238	2.642	2.200
8.53.B20105	254	2.739	2.300
8.53.B20115	354	3.762	3.100
8.53.B20171	326	3.526	2.800
8.53.B20180	427	4.604	3.800
8.53.B20211	593	6.206	4.100

Art.55B2 PLUS

Cod.	kg	LISTINO €	OFFERTA €
8.55.B20052	206	2.483	2.000
8.55.B20053	303	3.316	2.600
8.55.B20054	301	3.222	2.600
8.55.B20170	433	4.605	3.800
8.55.B20172	520	5.486	4.100
8.55.B20190	782	6.150	4.700

Art.57B2 PLUS

Cod.	kg	LISTINO €	OFFERTA €
8.57.B20100	155	1.812	1.600
8.57.B20110	241	2.277	2.000
8.57.B20120	216	2.233	1.950
8.57.B20130	232	2.596	2.150
8.57.B20140	325	2.875	2.400

A

Fusione in ghisa G30 monoblocco sgrassata con doppio trattamento di distensione. Pareti spessore 43-45 mm (Sovrametallo 10 mm)

B

Fusione sgrassata con base lavorata e raschiata per pallet a norme Europee o Giapponesi. Predisposizione della base di appoggio di n. 4 fori Ø 20F7 e filetto M16 con interassi precisi, pronte per l'utilizzo dei ns. Zero Point, oppure per l'interfacciamento con altri pallet o piastre. Pronto da installare ed azzerare con assi macchina.

C

Cubo completamente finito con pareti spessore 38-40 mm circa. Tolleranza ± 0,02 mm

B2 PLUS

Sovrametallo 1mm su ogni faccia. Pronto da installare e da azzerare con assi macchina

E

Cubo a reticolo con fori calibrati e filetti integrali. Tolleranza ± 0,02 mm

F

Cubo a reticolo con bussole temprate 100 Cr6 e filetti riportati in acciaio inox. Tolleranza ± 0,02 mm

CUBI MORSA INTEGRALI CON PIASTRA BASE

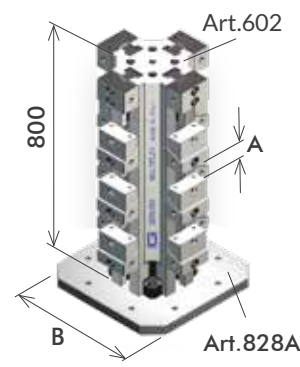
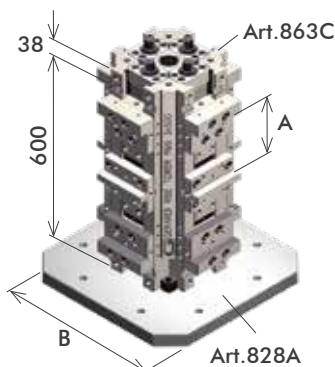
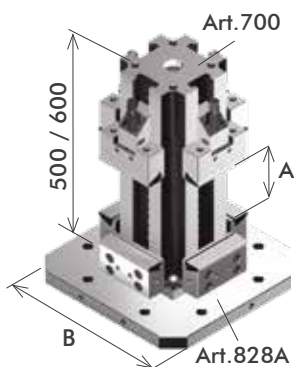

Art.700 + Art.828A (incluso)

Cubi-Morse modulari serie STD con piastra base personalizzata

Tipo	A 270 B 400	A 270 B 500	A 370 B 400	A 370 B 500
Cod.	3.70.01803	3.70.02803	3.70.03803	3.70.03803
LISTINO €	4.439	4.883	4.857	5.301
OFFERTA SPECIALE €	3.399	3.899	3.699	4.099

Art.863C + Art.828A (incluso)

Cubi-Morse modulari serie FMS con piastra base personalizzata

Tipo	3 - A 2x262 B 400	3 - A 2x262 B 500
Cod.	5.86.3C360	5.86.3C360
LISTINO €	13.334	13.778
OFFERTA SPECIALE €	9.999	10.399

Art.602 + Art.828A (incluso)

Cubi-Morse modulari serie MULTIFLEX con piastra base personalizzata

Tipo	2 - A 4x112 B 400	2 - A 4x112 B 500
Cod.	6.60.22800	6.60.22800
LISTINO €	10.350	10.794
OFFERTA SPECIALE €	7.799	8.199

PNEUMATICO MULTIPLO (IL CLASSICO)

Ripetibilità entro 0,005 mm



Dot. Standard:
1 firante Art.11A
1 tappo teflon con O-Ring Art.9

Art.664 CON FLANGIA



Tipo	1	2	3
Cod.	9.66.41000	9.66.42000	9.66.43000
kN	5,4	10	16
Doppio Effetto kN	NON DISPONIBILE		
LISTINO €	555	837	1.051
		€ 599	

Art.665 INCASSATO



Tipo	1	2	3
Cod.	9.66.51000	9.66.52000	9.66.53000
kN	5,4	10	16
Doppio Effetto kN	NON DISPONIBILE		
LISTINO €	448	726	946
		€ 499	

PNEUMATICO SINGOLO (L'ERMETICO)

Ripetibilità entro 0,005 mm

Art.664S CON FLANGIA

DOPPIO EFFETTO
ARIA + MOLLE

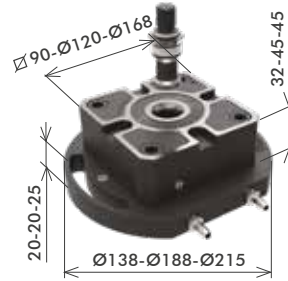

Tipo	1	2	3
Cod.	9.66.45100	9.66.45200	9.66.45300
kN	5,4	10	16
Doppio Effetto kN	12,7	27	40
LISTINO €	644	837	1.051
		€ 699	

Art.665S INCASSATO

DOPPIO EFFETTO
ARIA + MOLLE

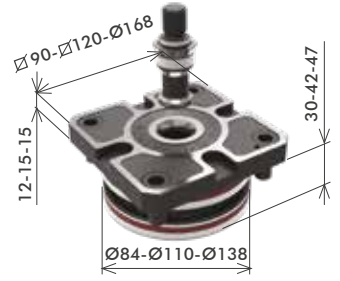

Tipo	1	2	3
Cod.	9.66.55100	9.66.55200	9.66.55300
kN	5,4	10	16
Doppio Effetto kN	12,7	27	40
LISTINO €	537	804	946
		€ 599	

Forza di serraggio 5 ÷ 40 kN / Forza di arresto oltre a 60 kN / Sbloccaggio ad aria 6 ÷ 10 bar / Compensazione assiale e radiale grazie alla pinza elastica integrale / Doppio centraggio per firante per massima rigidità / Pulizia ad aria / solo per ZERO POINT SINGOLI (versione S) 4 CHIAVETTE e FUNZIONE DOPPIOEFFETTO (Aria + molle)

KIT SOVRATAVOLE INTERFACCIE CON ZERO POINT PNEUMATICI

KIT #1 E #2 POSIZIONAMENTO & FISSAGGIO INCLUSI

KIT #3 E #4 POSIZIONAMENTO INCLUSO, FISSAGGIO (EXTRA)*

KIT #1 PER CENTRI VERTICALI

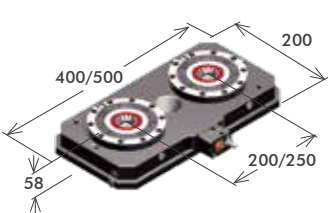

Art.81P	PIASTRA BASE
	200x400 200x500
LISTINO €	2.400 2.400
OFFERTA €	1.499 1.599

KIT #2 PER CENTRI ORIZZONTALI

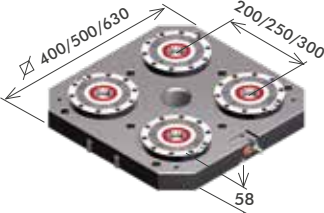

Art.80P	PIASTRA BASE
	400x400 500x500 630x630
LISTINO €	4.300 4.500 4.930
OFFERTA €	2.899 3.099 3.599

KIT #3 PER CENTRI VERTICALI

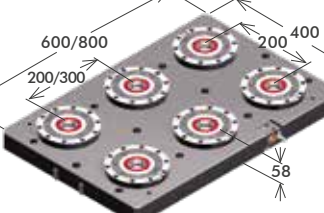

Art.81P	PIASTRA BASE
	400x600 400x800
LISTINO €	6.200 6.400
OFFERTA €	4.299 4.599

KIT #4 PER CENTRI A 5 ASSI

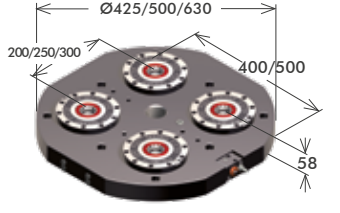

Art.82P	PIASTRA BASE TONDA
	Ø425 Ø500 Ø630
LISTINO €	4.500 4.480 5.000
OFFERTA €	3.199 3.299 3.799

PIASTRE D'INTERFACCIA PER ZERO POINT E PER TAVOLA MACCHINA

*Richiedi la scheda tecnica

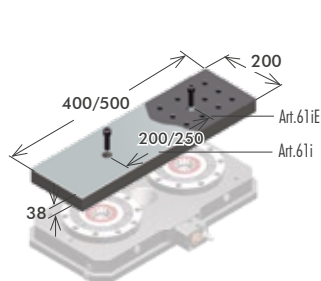

Art.61iC	LISCE
	200x400 200x500
LISTINO €	800 860
OFFERTA €	499 599

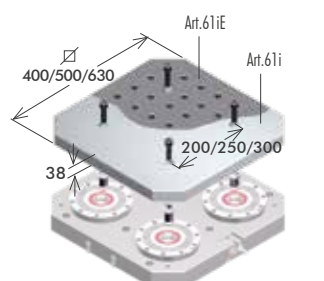

Art.60iC	LISCE
	400x400 500x500 630x630
LISTINO €	980 1.180 1.480
OFFERTA €	699 899 999

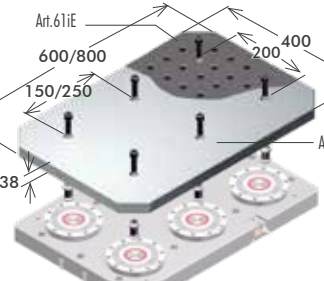

Art.61iC	LISCE
	400x600 400x800
LISTINO €	1.500 2.000
OFFERTA €	1.099 1.499

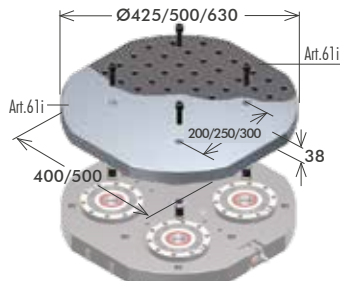

Art.62iC	LISCE
	Ø425 Ø500 Ø630
LISTINO €	1.050 1.200 1.400
OFFERTA €	799 949 1.099

Art.61iE	A RETICOLO INTEGRALE
LISTINO €	980 1.080
OFFERTA €	599 699

Art.61iE	A RETICOLO INTEGRALE
LISTINO €	1.300 1.700 2.670
OFFERTA €	899 1.199 1.999

Art.61iE	A RETICOLO INTEGRALE
LISTINO €	1.800 2.560
OFFERTA €	1.299 1.899

Art.62iE	A RETICOLO INTEGRALE
LISTINO €	1.300 1.660 2.220
OFFERTA €	949 1.199 1.599

Art.670

Modulo base morsa autocentrante idraulica o pneumatica

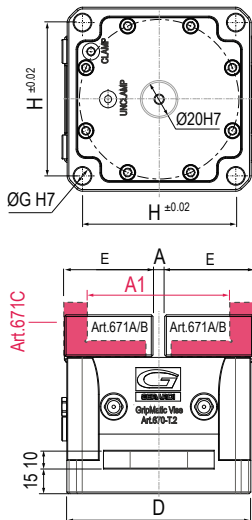
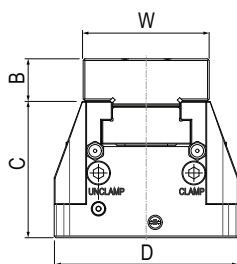

Art. 670P

Art. PN04

Niplon

Art. PN16

Dotazione Standard: - 4x Viti calibrate (Art.83) - Perno di centraggio (Art.670P)
- Valvola di non ritorno (Art.PN16) - 2 Niplon o 2 raccordi Art.PN04

Tipo	2	3	4
Larghezza ganascia W	74	99	124
Apertura massima A	6,4	8,5	12
Apertura massima A1	58,8	106,5	124,5
Altezza morsa C + B	105	135	165
Altezza base C	80	105	130
Larghezza morsa D	106	166	206
Larghezza ganasse E	52	78	96
Interasse fori di centraggio e fissaggio H	90	140	170
Pressione di esercizio	Max 10BAR		
Forza	5,1 kN	16 kN	22 kN
ART.670 Pneumatico - Cod.	7.67.OPN20	7.67.OPN30	7.67.OPN40
PREZZO LISTINO €	1.576	2.102	2.785
Pressione di esercizio	30 Bar	30Bar	25 Bar
Forza	15kN	25kN	45kN
ART.670 Idraulico - Cod.	7.67.OID20	7.67.OID30	7.67.OID40
PREZZO LISTINO €	1.576	2.102	2.785

PIASTRE D'INTERFACCIA

Piastre di interfaccia per morse GripMatic
IDEALE PER CENTRI A 5 ASSI

Art.670CP SEMI-AUTOMATICA

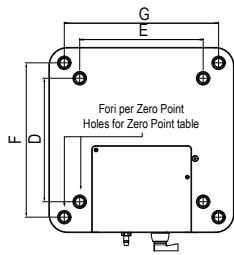
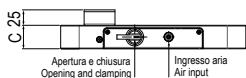
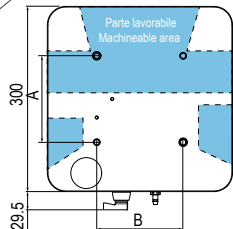

Piastre di interfaccia per morse Grip Matic Art.670 PN semiautomatica con innesto aria tramite attacco rapido e apertura e chiusura gestiti manualmente tramite selettore



Tipo	2	3	4
Interasse fori A	90	140	170
Interasse fori B	90	140	170
Altezza piastra C	38	38	38
Interasse fori (Zero Point) D	200	200	200
Interasse fori (Zero Point) E	200	200	200
Interasse fori (Zero Point) F	250	250	250
Interasse fori (Zero Point) G	250	250	250
Pressione di esercizio	Max 10BAR		
Forza	5,1 kN	16 kN	22 kN
Cod.	7.67.OCP20	7.67.OCP30	7.67.OCP40
PREZZO LISTINO €	2.000	2.000	2.000

Art.670AP AUTOMATICA

AUTOMATICA

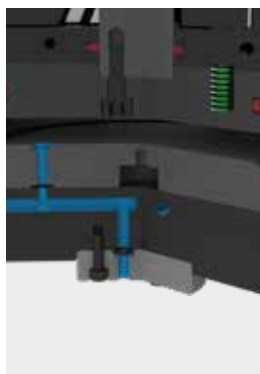

Piastre di interfaccia per morse Grip Matic Art.670PN automatica con innesto aria tramite la tavola della macchina e gestibile direttamente dal CNC. Piastra completamente personalizzabile in base alle funzionalità della macchina utensile (comando di presenza pezzo e pulizia)



PIASTRA PERSONALIZZABILE AL 100%

Tipo	2	3	4
Pressione di esercizio	Max 10BAR		
Forza	5,1 kN	16 kN	22 kN
ART.670 Pneumatico - Cod.	7.67.OAP20	7.67.OAP30	7.67.OAP40
PREZZO LISTINO € *	2.200	2.200	2.200

*Prezzo base minimo, PERSONALIZZAZIONE ESCLUSA

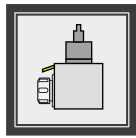

MOTORIZZATI

L'eccellenza tecnologica!
BMT 45/55/65/75/85

2 ANNI DI GARANZIA

RISPARMI FINO AL

30%

MADE IN ITALY

BMT

Bolt Mounted Turret

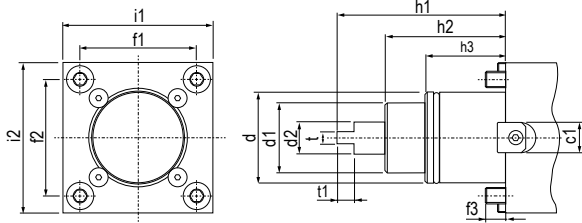

BMT	c1	d	d1	d2	f1	f2	f3	h1	h2	h3	i1	i2	t	t2
45	15	045	35	14	58	58	10	84	60	40	75	75	6	8,5
55	15	055	40	16	64	64	14	104	75	30	85	85	8	8,5
65	18	065	45	18	70	73	15	112	83	32	94	94	10	14
75	25	075	55	23	90	90	15	110	80	43	112	112	14	15
85	25	085	65	33,5	100	100	18	140	100	43	125	125	16	20

COMPATIBILI CON TORNII

DOOSAN / HARDINGE / SAMSUNG / HWACHEON / HYTNDU WUA / VICTOR / HAAS

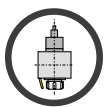

Assiali

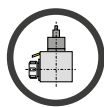
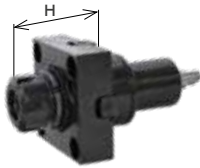

Radiali

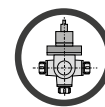

Orientabili

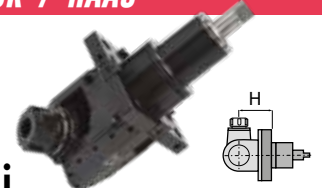

BMT 65 COMPATIBILI ANCHE CON TORNII HAAS!

BMT	Cod.	ER	H	Nm	Rpm	PREZZO LISTINO €	PREZZO SPECIALE €	BMT	Cod.	ER	H	Nm	Rpm	PREZZO LISTINO €	PREZZO SPECIALE €	BMT	Cod.	ER	H	Nm	Rpm	PREZZO LISTINO €	PREZZO SPECIALE €
45	99.DS.A03	25	Max 57,2	35	8000	972	799	45	99.DS.A07C	25	65	35	8000	1.716	1.399	45	99.DS.A16	20	65	15	8000	4.428	3.599
	99.DS.A04	25	Max 57,2	35	8000	1.110	899		99.DS.A08C	25	65	35	8000	2.064	1.699		99.DS.A17	20	65	15	8000	5.760	4.599
55	99.DS.A01	25	Max 57,2	40	8000	1.020	799	55	99.DS.A11C	25	70	40	8000	1.920	1.399	55	99.DS.A23	20	65	15	8000	4.428	3.599
	99.DS.A02	25	Max 57,2	40	8000	1.170	899		99.DS.A12C	25	70	40	8000	2.268	1.699		99.DS.A66	20	65	15	8000	5.760	4.599
65	99.DS.A41	32	Max 72,5	70	6000	1.200	899	65	99.DS.A51C	32	72	70	6000	2.016	1.499	65	99.DS.A64	25	75	25	6000	4.920	3.999
	99.DS.A42	32	Max 72,5	70	6000	1.380	999		99.DS.A52C	32	72	70	6000	2.388	1.799		99.DS.A65	25	75	25	6000	6.360	5.099
75	99.DS.A34	40	Max 90,2	100	6000	1.410	1.199	75	99.DS.A38C	40	60	100	6000	3.120	2.499	75	99.DS.A47	25	75	25	6000	4.920	3.999
	99.DS.A35	40	Max 90,2	100	6000	1.620	1.299		99.DS.A39C	40	60	100	6000	3.744	2.999		99.DS.A48	25	75	25	6000	6.360	5.099

Entrambe direzioni di rotazione disponibili



CAMBI RAPIDI UNIVERSALI

Compatibili con tutte le uscite ER

MADE IN ITALY

NUOVI MODELLI 2.0

OFFERTA MODELLI 1.0

- Tempi di installazione ridotti e possibilità di presetting a bordo macchina
- Nuovi cambi rapidi modulari 2.0 a FORTE SERRAGGIO
- Portautensili modulari compatibili con tutte le uscite ER.
- Prestazioni garantite e maggior rigidità sui motorizzati Gerardi grazie alla losanga di trascinamento (rimovibile) e alla ghiera con cuscinetto a sfera.
- Adattabili a motorizzati con uscita refrigerante sia interna che esterna.

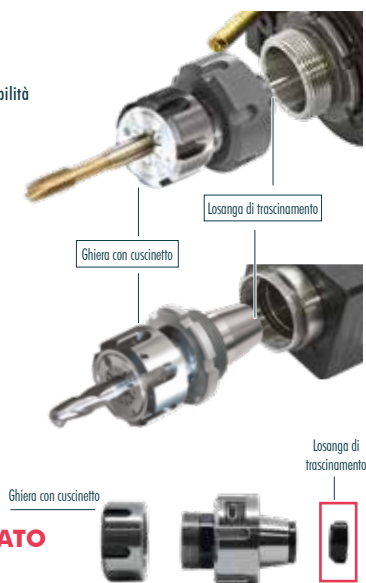

BREVETTO DEPOSITATO
LOSANGA DI TRASCINAMENTO

KIT #1



Acquistando un Cambi Rapido Modulare (Ghiera Interna o Esterna) **A SCELTA**

KIT #2



Acquistando 2 Motorizzati + 2 Cambi Rapidi

KIT #3



Acquistando un Kit di 3 Cambi Rapidi (Ghiera Interna o Esterna)

Prezzo di listino 400 € cad.

Risparmi il **15%**

Risparmi il **30%** sui 2 cambi rapidi ordinati se ordini 1 cambio rapido

and SAVE **30%**



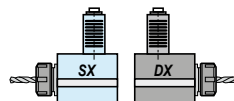
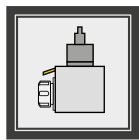

Sinistro - Destro

DIN 5480

* In caso di ordine specificare sempre se sinistro o destro

VDI - DIN69880

d1	Cod.	ER	H	Nm	Rpm	PREZZO LISTINO €	PREZZO SPECIALE €
30	99.ST.8003	25	66	32	6000	864	699
	99.ST.8011	25	66	32	6000	1.116	899
40	99.ST.8005	32	95	63	6000	1.080	849
	99.ST.8013	32	95	63	6000	1.412	1.099

🔄 Senso di rotazione uguale al mandrino

30	99.ST.8030	25	55	32	6000	1.814	1.399
	99.ST.8038	25	55	32	6000	2.088	1.749
40	99.ST.8033	32	100	63	6000	2.296	1.699
	99.ST.8041	32	100	63	6000	2.636	1.999

🔄 Senso di rotazione contrario al mandrino

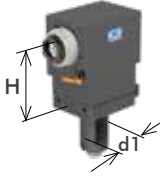

DIN 5482

* In caso di ordine specificare sempre se sinistro o destro

VDI - DIN69880

d1	Cod.	ER	H	Nm	Rpm	PREZZO LISTINO €	PREZZO SPECIALE €
30	99.ST.8201	25	94	32	6000	814	699
	99.ST.8207	25	94	32	6000	1.094	899
40	99.ST.8203	32	115	63	5000	980	799
	99.ST.8208	32	115	63	5000	1.268	999

🔄 Senso di rotazione uguale al mandrino

30	99.ST.8217	25	55	32	6000	1.634	1.299
	99.ST.8223	25	55	32	6000	1.908	1.499
40	99.ST.8220	32	100	63	5000	1.958	1.499
	99.ST.8226	32	100	63	5000	2.290	1.799

🔄 Senso di rotazione contrario al mandrino

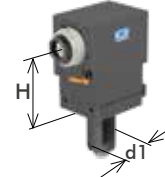
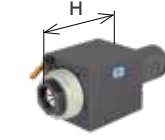

* In caso di ordine specificare sempre se sinistro o destro

VDI - DIN69880

d1	Cod.	ER	H	Nm	Rpm	PREZZO LISTINO €	PREZZO SPECIALE €
30	99.BF.0003	25	94	32	6000	842	699
	99.BF.0010	25	94	32	6000	1.124	899
40	99.BF.0005	32	117	63	5000	1.016	799
	99.BF.0011	32	115	63	5000	1.310	1.099

🔄 Senso di rotazione uguale al mandrino

30	99.BF.0021	25	55	32	6000	1.678	1.399
	99.BF.0027	25	55	32	6000	1.966	1.599
40	99.BF.0024	32	53	63	5000	2.016	1.599
	99.BF.0030	32	53	63	5000	2.362	1.899

🔄 Senso di rotazione contrario al mandrino

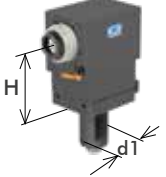
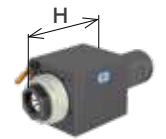

DIN 1809

* In caso di ordine specificare sempre se sinistro o destro

VDI - DIN69880

d1	Cod.	ER	H	Nm	Rpm	PREZZO LISTINO €	PREZZO SPECIALE €
30	99.DP.0903	25	94	32	6000	814	699
	99.DP.0910	25	94	32	6000	1.094	899
40	99.DP.0905	32	115	63	5000	980	799
	99.DP.0911	32	115	63	5000	1.268	999

🔄 Senso di rotazione uguale al mandrino

30	99.DP.0919	25	55	32	6000	1.634	1.299
	99.DP.0925	25	55	32	6000	1.908	1.499
40	99.DP.0922	32	100	63	5000	1.958	1.499
	99.DP.0928	32	100	63	5000	2.290	1.799

🔄 Senso di rotazione contrario al mandrino

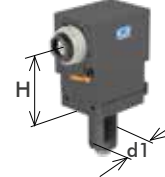
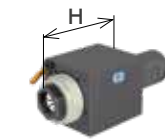

BMT 55

d1	Cod.	ER	H	Rpm	PREZZO LISTINO €	PREZZO SPECIALE €
55	99.BG.B02.A	32	83,5	4.000	1.010	899
	99.BG.B02.D	32	83,5	4.000	1.475	1.299

🔄 Senso di rotazione uguale al mandrino

55	99.BG.B05.A	32	70	4000	1.400	1.399
	99.BG.B05.B	32	70	4000	1.680	1.599

🔄 Senso di rotazione uguale al mandrino



NLX 1500 - 2000 - 2500 - 3000 12 Posizioni

NZX 12 Posizioni

Cod.	ER	H	Nm	Rpm	PREZZO LISTINO €	PREZZO SPECIALE €
99.MS.G59	32	86,2÷89,9	60	10.000	1.176	899
99.MS.G60	32	86,2÷89,9	60	10.000	1.740	1.199
99.MS.G62	40	88,5÷92	60	10.000	1.176	899
99.MS.G63	40	88,3÷92	60	10.000	1.740	1.199

99.MS.A72	32	Max 90	60	10.000	2.520	1.849
99.MS.A73	32	Max 90	60	10.000	2.820	2.049
99.MS.A76	40	90	60	10.000	2.520	1.849
99.MS.A77	40	90	60	10.000	2.820	2.049

🔄🔄 Entrambe direzioni di rotazione disponibili*

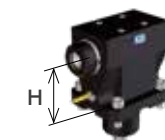
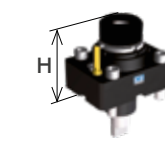

BMT 40: B436



d1	Cod.	ER	H	Rpm	PREZZO LISTINO €	PREZZO SPECIALE €
40	99.BG.B40	20	57	6.000	1.322	1.299
	99.BG.B41	20	57	6.000	1.742	1.699

🔄 Senso di rotazione uguale al mandrino

40	99.BG.B46	20	70	6.000	2.567	2.499
	99.BG.B47	20	45	6.000	2.645	2.599

🔄 Senso di rotazione uguale al mandrino



NZ 1500 - 2000 - 3100 - 3150 - 3200 16 Posizioni



Cod.	ER	H	Nm	Rpm	PREZZO LISTINO €	PREZZO SPECIALE €
99.MS.A101	25	80,6÷84,3	50	12.000	1.176	949
99.MS.A102	25	80,6÷84,3	50	12.000	1.740	1.299
99.MS.A103	32	85,5÷89,2	50	12.000	1.176	949
99.MS.A104	32	85,5÷89,2	50	12.000	1.740	1.299

🔄 Senso di rotazione uguale al mandrino

99.MS.A106	25	85	50	12.000	2.520	1.849
99.MS.A107	25	85	50	12.000	2.820	2.049
99.MS.A108	32	85	50	12.000	2.520	1.849
99.MS.A109	32	85	50	12.000	2.820	2.049

🔄 Senso di rotazione contrario al mandrino

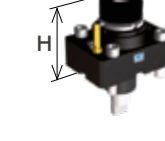

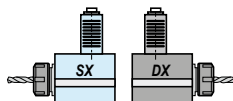
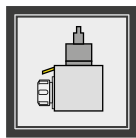

Sinistro - Destro



VDI 40

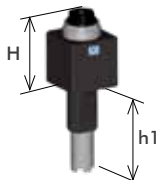

Cod.	ER	H	h1	Nm	Rpm	PREZZO LISTINO €	PREZZO SPECIALE €
99.HA.590082	32	75	117,5	63	6000	890	699
99.HA.590082B	32	75	117,5	63	6000	1.110	899
99.HA.590083	32	75	104,8	63	6000	890	699
99.HA.590083B	32	75	104,8	63	6000	1.110	899
99.HA.596352	32	75	130,25	63	6000	890	699
99.HA.596352B	32	75	130,25	63	6000	1.110	899

Senso di rotazione uguale al mandrino



Presi di moto intercambiabile per le varie tipologie di torrette Haas



Cod.	ER	H	h1	Nm	Rpm	PREZZO LISTINO €	PREZZO SPECIALE €
99.HA.590084	32	75	117,5	63	6000	1.670	1.299
99.HA.590084B	32	75	117,5	63	6000	2.110	1.699
99.HA.590085	32	75	104,8	63	6000	1.670	1.299
99.HA.590085B	32	75	104,8	63	6000	2.110	1.699
99.HA.596353	32	75	130,25	63	6000	1.670	1.299
99.HA.596353B	32	75	130,25	63	6000	2.110	1.699

Senso di rotazione uguale al mandrino

Mazak

QTN2 12 Posizioni

QUICK TURN NEXUS QTN 200/250
SUPER QUADREX TURN SQT 15/18 - 200/250



Cod.	ER	H	Nm	Rpm	PREZZO LISTINO €	PREZZO SPECIALE €
99.MZ.A58	32	116,2÷120	80	6000	1.560	1.399
99.MZ.A59	32	116,2÷120	80	6000	2.400	1.799



99.MZ.A65	32	130	80	6000	1.667	1.499
99.MZ.A66	32	130	80	6000	2.200	1.799

Senso di rotazione contrario al mandrino

Mazak

SMART QTS1 - BMT68

QUICK TURN SMART QTS 100M / 200M
QT COMPACT 100M - 200M - 300M



Cod.	ER	H	Nm	Rpm	PREZZO LISTINO €	PREZZO SPECIALE €
99.MZ.A03	32	Max70	60	6000	1.555	1.299
99.MZ.A06	32	Max70	60	6000	2.110	1.699



99.MZ.A09	32	80	60	6000	2.220	1.799
99.MZ.A10	32	80	60	6000	2.780	2.399

Senso di rotazione contrario al mandrino

Miyano

Ø45: WT100 -TW1

Ø54: WT100 -TW1



d1	Cod.	ER	H	Nm	Rpm	PREZZO LISTINO €	PREZZO SPECIALE €
45	99.MY.A02	25	53,9÷57,6	35	6000	803	699
	99.MY.A03	25	53,9÷57,6	35	6000	963	799
54	99.MY.A09	32	75,7÷79,4	60	6000	935	799
	99.MY.A10	32	75,7÷79,4	60	6000	1.073	899



45	99.MY.A05	25	65	35	6000	1.419	1.199
	99.MY.A06	25	65	35	6000	1.705	1.399
54	99.MY.A11	32	75	60	6000	1.760	1.399
	99.MY.A12	32	75	60	6000	2.079	1.699

Senso di rotazione contrario al mandrino



BMT44 WT100 -TW1

BMT55 SUPER NTJ-NTJX / NTM 3 / TMC 18 / TW10 / SC150-250 / WT150-250 / WTW 150 / WTS 150 / WT100

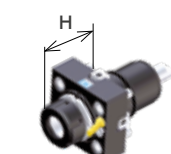

d1	Cod.	ER	H	Nm	Rpm	PREZZO LISTINO €	PREZZO SPECIALE €
45	99.NK.A40	25	Max57,2	40	6000	891	699
	99.NK.A43	25	Max57,2	40	6000	1.018	799
55	99.NK.A03	32	68,5÷72,2	63	6000	935	799
	99.NK.A04	32	68,5÷72,2	63	6000	1.441	1.199



45	99.NK.A50	25	60	40	6000	1.579	1.299
	99.NK.A53	25	60	40	6000	1.892	1.499
55	99.NK.A13	32	55	63	6000	1.760	1.399
	99.NK.A14	32	55	63	6000	2.373	1.899

LOKUMA

BMT60: SPACE TURN LB 200EX / LB 2500EX / LB3000EX / GENOS SERIES L300-MW / MULTUS U3000 / U40007 / LU3000EX M / MY



d1	Cod.	ER	H	Nm	Rpm	PREZZO LISTINO €	PREZZO SPECIALE €
60	99.OK.A80	32	Max79	60	6000	1.589	1.199
	99.OK.A81	32	Max79	60	6000	2.017	1.499

Senso di rotazione uguale al mandrino



60	99.OK.A82	32	70	60	6000	2.872	1.999
	99.OK.A83	32	70	60	6000	3.422	2.399

Senso di rotazione contrario al mandrino



BMT65: M06D / M06SD / M06SY / M08SD / M08SY



Cod.	ER	H	Nm	Rpm	PREZZO LISTINO €	PREZZO SPECIALE €
99.TS.A01	25	MAX 60	40	8000	1.467	1.199
99.TS.A02	25	MAX 60	40	8000	2.017	1.599



99.TS.A08	25	65	40	8000	2.383	1.899
99.TS.A09	25	65	40	8000	2.933	2.399

Progettiamo e realizziamo porta utensili motorizzati ORIENTABILI che permettono fresature, forature e maschiature con diverse angolazioni ($\pm 90^\circ$)



PRECISIONE E AFFIDABILITÀ GARANTITE 2 ANNI !!

**ASSISTENZA RAPIDA ED ECONOMICA
ESEGUITA DAI NOSTRI SPECIALISTI !**

Corpo

Tattamento protettivo anti-ossidante del corpo in acciaio integrale a sezione maggiorata per ridurre vibrazioni e aumentare la rigidità

Refrigerazione Interna

Tutti i Motorizzati possono essere forniti con refrigerante interno e pressione fino 100bar. Rotazione a secco possibile!

Coppia & Rpm

Coppia disponibile fino a 100Nm e velocità fino a 12.000 Rpm

Uscite

Pinze ER / WELDON / HSK / CAT / SK / BT / CAPTO o uscite portafresa

Ingranaggi Gleason

Coppia conica di ingranaggi spirodali Gleason con evolvente rettificato per garantire una maggior forza e ridurre rumore e riscaldamento

Cuscinetti

Cuscinetti a contatto obliquo + cuscinetti a rulli conici su lato mandrino per maggiore rigidità e durata nel tempo



Ø45: ABX 51/64 TH2/TH3
BNE 34/42 - BNJ 42/51
Ø54: ABX 51/64 THY - ABX 51/64 SY



Ø	Cod.	ER	H	Nm	Rpm	PREZZO LISTINO €	PREZZO SPECIALE €
45	99.MY.A08	20	65	15	6000	4.059	3.299
	99.MY.A13	20	65	15	6000	5.280	4.299
54	99.MY.A19	20	75	15	6000	4.510	3.599
	99.MY.A20	20	75	15	6000	5.867	4.699

Senso di rotazione uguale al mandrino



BMT55

SUPER NTJ-NTJX / NTM 3 / TMC 18 / TW10 / SC150-250 / WT150-250 / WTW 150 / WTS 150 / WT100

BMT44

WT100 -TW1



BMT	Cod.	ER	H	Rpm	PREZZO LISTINO €	PREZZO SPECIALE €
44	99.NK.A59	16	68,5	6.000	4.059	3.299
	99.NK.A69	16	68,5	6.000	5.867	4.699
55	99.NK.A22	20	71	6000	4.059	3.299
	99.NK.A32	20	71	6000	5.280	4.199
65	99.NK.A82	25	80	6000	4.059	3.299

Senso di rotazione uguale al mandrino



BMT65:

M06D / M06SD / M06SY / M08D / M08SD / M08SY



Cod.	ER	H	Nm	Rpm	PREZZO LISTINO €	PREZZO SPECIALE €
99.TS.A24	20	65	15	8000	5.012	3.999
99.TS.A25	20	65	40	8000	6.478	5.199

Senso di rotazione uguale al mandrino



Bolt Mounted Turret



BMT 45 - 55 - 65 - 75

BMT	Cod.	ER	H	Nm	Rpm	PREZZO LISTINO €	PREZZO SPECIALE €
45	99.DS.A16	20	65	15	8000	4.428	3.599
	99.DS.A17	20	65	15	8000	5.760	4.599
55	99.DS.A23	20	65	15	8000	4.428	3.599
	99.DS.A66	20	65	15	8000	5.760	4.599
65	99.DS.A64	25	75	25	6000	4.920	3.999
	99.DS.A65	25	75	25	6000	6.360	5.099
75	99.DS.A47	25	75	25	6000	4.920	3.999
	99.DS.A48	25	75	25	6000	6.360	5.099

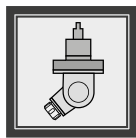

DIN 5480

VDI - DIN69880

d1	Cod.	ER	H	Nm	Rpm	PREZZO LISTINO €	PREZZO SPECIALE €
30	99.ST.8087	20	64	15	6000	4.176	3.399
	99.ST.8088	20	97	15	6000	4.176	3.399
	99.ST.8091	20	64	15	6000	4.752	3.799
	99.ST.8092	20	97	15	6000	4.752	3.799
40	99.ST.8089	25	81	25	4000	4.752	3.799
	99.ST.8093	25	81	25	4000	5.472	4.399
50	99.ST.8090	40	123	50	4000	6.478	5.199

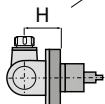

Senso di rotazione contrario al mandrino

DIN 5482

VDI - DIN69880

d1	Cod.	ER	H	Nm	Rpm	PREZZO LISTINO €	PREZZO SPECIALE €
30	99.ST.8248	20	64	15	6000	4.176	3.399
	99.ST.8249	20	97	15	6000	4.176	3.399
	99.ST.8254	20	97	15	6000	4.752	3.799
	99.ST.8250	25	81	25	5000	4.752	3.799
40	99.ST.8255	25	81	25	5000	5.472	4.399
	99.ST.8251	25	100	25	4000	5.012	3.999

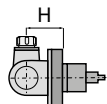

Senso di rotazione contrario al mandrino



VDI - DIN69880

d1	Cod.	ER	H	Nm	Rpm	PREZZO LISTINO €	PREZZO SPECIALE €
30	99.BF.0051	20	64	15	6000	4.176	3.399
	99.BF.0052	20	97	15	6000	4.176	3.399
	99.BF.0054	20	64	15	6000	4.752	3.799
	99.BF.0055	20	97	15	6000	4.752	3.799
40	99.BF.0053	25	81	25	5000	4.752	3.799
	99.BF.0056	25	81	25	5000	5.472	4.399

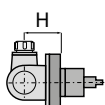

Senso di rotazione contrario al mandrino

DIN 1809

VDI - DIN69880

d1	Cod.	ER	H	Nm	Rpm	PREZZO LISTINO €	PREZZO SPECIALE €
30	99.DP.0940	20	64	15	6000	4.176	3.399
	99.DP.0941	20	97	15	6000	4.176	3.399
	99.DP.0943	20	64	15	6000	4.752	3.799
	99.DP.0944	20	97	15	6000	4.752	3.799
40	99.DP.0942	25	81	25	5000	4.752	3.799
	99.DP.0945	25	81	25	5000	5.472	4.399

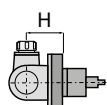

Senso di rotazione contrario al mandrino



BMT 40 - 55

BMT	Cod.	ER	H	Rpm	PREZZO LISTINO €	PREZZO SPECIALE €
40	99.BG.B55	11	91,5	6.000	4.666	4.200
	99.BG.B56	16	105	6.000	4.822	4.350
55	99.BG.B10	20	140	4000	3.400	3.300
	99.BG.B11	16	111	4000	3.660	3.550

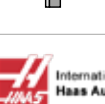
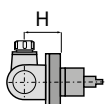

Senso di rotazione contrario al mandrino



NLX - NZX - NZ - SL - ZL - DL

d1	Cod.	ER	H	Nm	Rpm	PREZZO LISTINO €	PREZZO SPECIALE €
NLX	99.MS.A86	25	78	25	10.000	4.920	3.999
	99.MS.A87	25	78	25	10.000	6.360	5.099
NZ	99.MS.A118	20	50	17	12.000	4.920	3.399
	99.MS.A119	20	50	17	12.000	6.360	5.099
SL	99.MS.A55	20	66	25	6.000	4.510	3.699
ZL	99.MS.A56	20	66	25	6.000	5.830	4.699
DL							

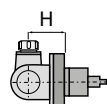

Senso di rotazione uguale al mandrino

Senso di rotazione contrario al mandrino



VDI 40



Presca di moto intercambiabile per le varie tipologie di torrette Haas

Cod.	ER	H	h1	Nm	Rpm	PREZZO LISTINO €	PREZZO SPECIALE €
99.HA.00U1	25	81	69,3	25	6000	4.752	3.799
99.HA.00U1B	25	83	69,3	25	6000	5.472	4.399
99.HA.00U2	25	81	69,3	25	5000	4.752	3.799
99.HA.00U2B	25	81	69,3	25	5000	5.472	4.399
99.HA.00U3	25	81	69,3	25	6000	4.752	3.799
99.HA.00U3B	25	81	69,3	25	6000	5.472	4.399

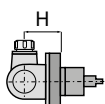

Senso di rotazione uguale al mandrino



QTN1 - QTN2 - QTN3 - QTS

d1	Cod.	ER	H	Nm	Rpm	PREZZO LISTINO €	PREZZO SPECIALE €
QTN1	99.MZ.A56	20	85	63	6000	3.600	3.399
QTN2	99.MZ.A74	25	85	80	6000	4.800	3.699
	99.MZ.A64	25	85	80	6000	4.800	4.399
QTN3	99.MZ.A80	32	85	100	4000	6.000	4.999
QTS	99.MZ.A14	25	80	30	6000	5.470	4.899
	99.MZ.A15	25	80	30	6000	6.480	5.699

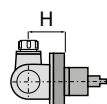

Senso di rotazione contrario al mandrino

Senso di rotazione uguale al mandrino

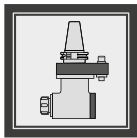

TESTE ANGOLARI

Versatilità & Rigidità!

IDEALI PER CENTRI VERTICALI E ORIZZONTALI



Classic Line

SERIE INTEGRALI

Maggior rigidità e compattezza grazie all'albero ed il cono integrali.

Con e senza Refrigerante Interno.

SERIE ATC (Cambio Utensile Automatico)

TIPO 1 (Ø90)

Modello	ER	Rpm Max	Nm	PREZZO LISTINO €	Modello serie Lunga	PREZZO LISTINO €
9.G90.05000	ER-8	10.000	4	3.030		-
9.G90.07000	ER-11	10.000	5	3.540		3.703
9.G90.10000	ER-16	10.000	10	2.865		3.581
9.G90.16000	ER-25	8.000	24	3.493		4.305
9.GMU.13000	ER-20	4.000	6	3.890		-
9.GMU.16000	ER-25	4.000	18	4.093		-

TIPO 2 (Ø110)

9.G90.20000	ER-32	4.000	40	3.693		4.616
9.GMU.20000	ER-32	4.000	32	4.384		-

TIPO 3 (Ø170)

9.G90.S40000	ISO / CAT / BT40	4.000	140	5.321		6.518
--------------	------------------	-------	-----	-------	--	-------

BT40 cono standard incluso

2 ANNI DI GARANZIA

OFFERTA KIT INTERFACCIA

Evolution Line

SERIE MODULARE

Con coni intercambiabili per un utilizzo su più centri di lavoro. Con e senza Refrigerante Interno.



€ 200,00

SERIE ATC (Cambio Utensile Automatico)

TIPO 1 (Ø102)

Modello	ER	Rpm Max	Nm	PREZZO LISTINO €	Modello serie Lunga	PREZZO LISTINO €
9.FS9.03000	6023E	8.000	2	4.540		5.065
9.FS9.04000	600E	8.000	3,5	4.195		4.860
9.F90.07000	ER-11	10.000	6	3.333		3.690
9.F90.10000	ER-16	10.000	11	2.760		3.425
9.F90.16500	ER-25	8.000	27	3.390		-
9.FMU.10000	ER-16	8.000	9	3.544		-
9.FMU.16000	ER-25mini	6.000	15	3.800		-

TIPO 2 (Ø128)

9.F90.16000	ER-25	5.000	46	3.400		4.222
9.F90.20000	ER-32	3.500	85	3.800		5.000

TIPO 3 (Ø157)

9.F90.S4000	ISO / CAT / BT40	2.500	135	4.400		-
9.FMU20000	ER-32 mini	4.000	48	4.911		-

KIT 1 CLASSIC LINE

1 Cambio rapido COMPRESO acquistando 1 Testa G90-16



α € 3.300
anzichè € 3.893

oppure



Acquista 1 Testa G90-16

α € 2.999
anzichè € 3.493

KIT 2 GHIERA RE-COOL

Acquistando 1 Testa Angolare Classic Line + 1 Ghiera RE-COOL

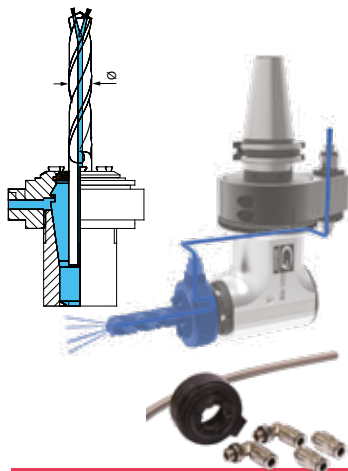

RISPARMIA IL -25%
(25% sulla ghiera RE-COOL)

KIT 3 EVOLUTION LINE

1 Cambio rapido COMPRESO acquistando 1 Testa F90-16S



α € 3.300
anzichè € 3.790

oppure



Acquista 1 Testa F90-16S

α € 2.999
anzichè € 3.390

KIT 4 GHIERA RE-COOL

Acquistando 1 Testa Angolare Evolution + 1 Ghiera RE-COOL

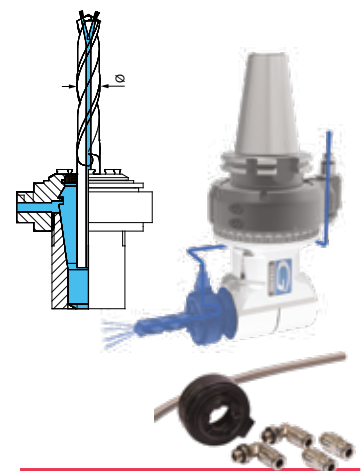

RISPARMIA IL -25%
(25% sulla ghiera RE-COOL)



GERARDI SPA

via Giovanni XXIII, 101
21015 LONATE POZZOLO (VA) Italia
Tel. +39.0331.303911 - Fax +39.0331.301534
gerardi@gerardispa.com - www.gerardi.it

Distributore: