



www.gerardi.it

ITALIANO



OFFERTA SPECIALE 2016 #1

SCADENZA
31 Luglio 2016

All'interno:



MORSE STD & StdFLEX



MORSE FMS



MULTIFLEX VISES



MORSE MULTITASKING



ZERO POINT



CUBI PORTAPEZZI



TESTE ANGOLARI



MOTORIZZATI



RISPARMI FINO AL
50%



StandardFLEX

Geniale sistema a pettine per la rapida sostituzione delle piastre ganasce discendenti

Risparmi fino al **23%**

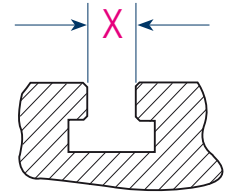
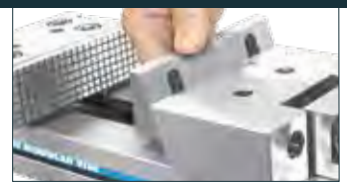

Morsa modulare di precisione serie StandardFLEX con dotazione standard +

in Omaggio: n. 4 staffe Art. 298 + n.4 dadi a "T" Art.287



Tipo di morsa	2 - 25kN		3 - 30kN		4 - 30kN			5 - 40kN		
Apertura massima A	150	200	300	200	300	400	200	300	400	
Larghezza ganasce W	121 mm	146 mm		171 mm			196 mm			
Altezza ganasce B	38	48		58			63			
Lunghezza base D	345	420	520	455	555	655	495	595	695	
Cod.	1.1A.20000	1.1A.32000	1.1A.33000	1.1A.42000	1.1A.43000	1.1A.44000	1.1A.52000	1.1A.53000	1.1A.54000	
PREZZO LISTINO €	759	912	1.052	1.161	1.277	1.393	1.517	1.816	2.121	
PREZZO OFFERTA €	675	729	829	999	1.049	1.149	1.349	1.599	1.799	

Art.1A

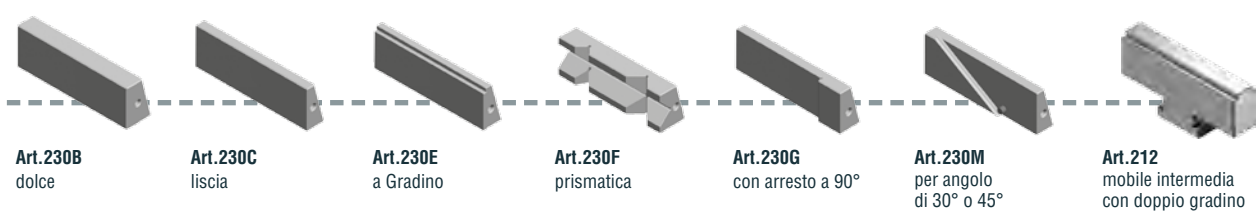

* Risparmi il **25%**

Art.230B dolce
Art.230C liscia
Art.230E a Gradino
Art.230F prismatica
Art.230G con arresto a 90°
Art.230M per angolo di 30° o 45°
Art.212 mobile intermedia con doppio gradino



XL

Morse con la base molto più lunga delle normali morse standard



Morsa serie XL con dotazione standard +

In omaggio: n. 6 staffe Art. 298 + n.6 dadi a "T" Art.287

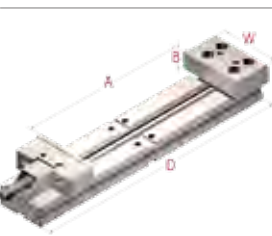

Tipo di morsa	2 - 25kN		3 - 30kN		4 - 30kN				5 - 40kN			
Apertura massima A	320	360	460	400	500	600	700	500	600	700	800	
Larghezza ganasce W	125 mm	150 mm		175 mm				200 mm				
Altezza ganasce B	40	50		60				65				
Lunghezza base D	520	580	680	666	766	866	966	805	905	1005	1105	
Cod.	2.21.23200	2.21.33600	2.21.34600	2.21.44000	2.21.45000	2.21.46000	2.21.47000	2.21.55000	2.21.56000	2.21.57000	2.21.58000	
kg	17	32	35	47	52	56	61	64	69	74	79	
PREZZO LISTINO €	941	1.169	1.296	1.365	1.501	1.634	1.773	2.318	2.586	2.856	3.125	
PREZZO OFFERTA €	750	900	1.000	1.150	1.250	1.350	1.450	1.800	2.000	2.200	2.400	

LE PIÙ VENDUTE

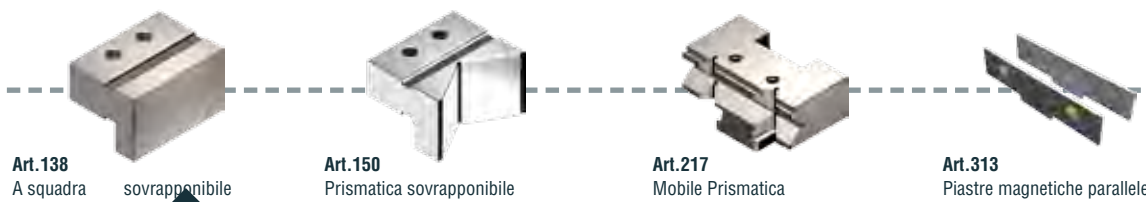

* Risparmi il **25%**

Art.138 A squadra sovrapponibile
Art.150 Prismatica sovrapponibile
Art.217 Mobile Prismatica
Art.313 Piastre magnetiche parallele piane

* Sui prezzi di listino attuali



SCADENZA 31 Luglio 2016

Tutti i componenti sono in acciaio cementato, temprato e rettificato



Multiflex

Per serraggi multipli da 1 fino a 12 pezzi anche di diverse dimensioni

Risparmi fino al **32%**



In omaggio: n. 6 staffe Art. 298 +

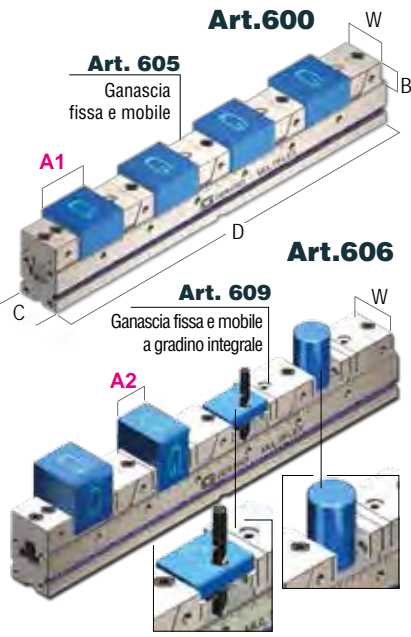

Ogni morsa è predisposta per il serraggio di 4 pezzi
Dot. Std : Chiavi a "T", 2 tasselli di posizionamento e 4 arresti laterali +

Tipo	Art.600							Art.606				
	mm	B	C ^{+0 -0.02}	D	W	A1mm	Cod	LISTINO PREZZI €	PREZZO SPECIALE €	A2mm	Cod	LISTINO PREZZI €
1 20kN	32/25	50	300	49	4x8	6.60.01300	988	670	3x19	6.60.61300	1.496	1.100
	32/25	50	400	49	4x33	6.60.01400	1.073	770	4x23	6.60.61400	1.559	1.200
	32/25	50	500	49	4x58	6.60.01500	1.169	870	4x48	6.60.61500	1.654	1.300
	32/25	50	600	49	4x83	6.60.01600	1.275	970	4x73	6.60.61600	1.759	1.400
	32/25	50	700	49	4x108	6.60.01700	1.426	1.070	4x97	6.60.61700	1.912	1.500
2 30kN	40	75	400	74	4x12	6.60.02400	1.285	970	3x28	6.60.62400	1.862	1.400
	40	75	500	74	4x37	6.60.02500	1.381	1.100	4x24	6.60.62500	1.959	1.500
	40	75	600	74	4x62	6.60.02600	1.487	1.200	4x49	6.60.62600	2.068	1.600
	40	75	700	74	4x87	6.60.02700	1.593	1.300	4x74	6.60.62700	2.174	1.700
	40	75	800	74	4x112	6.60.02800	1.737	1.400	4x99	6.60.62800	2.328	1.800
NEW	40	75	900	74	4x137,5	6.60.02900	1.891	1.600	4x124,5	6.60.62900	2.482	1.900
3 40kN	60	100	700	99	4x59	6.60.03700	1.843	1.500	4x44	6.60.63700	2.512	2.000
	60	100	800	99	4x84	6.60.03800	1.996	1.600	4x69	6.60.63800	2.666	2.100
	60	100	900	99	4x109	6.60.03900	2.151	1.800	4x94	6.60.63900	2.820	2.300
	60	100	1000	99	4x134	6.60.03100	2.357	2.000	4x119	6.60.63100	3.026	2.500

OFFERTA PIASTRE PARALLELE MAGNETICHE E RIPORTATE:

* Risparmi il **50%**

Art.616
Coppia di piastre parallele magnetiche piane per Art. 600



ESEMPIO:
Art.600 2x600 con 4 coppie di piastre parallele magnetiche

LISTINO PREZZI:
€1.200+ €104 anziché € 208

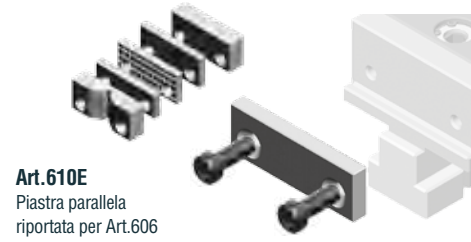

Art.610E
Piastra parallela riportata per Art.606



Multitasking

Morse autocentranti o eccentriche
Ideali per centri di lavoro a 5 assi

Risparmi fino al **38%**

DISPONIBILI ANCHE: Ganasce Lisce, Tenere, Prismatiche o Grip



* Risparmi il **20%**

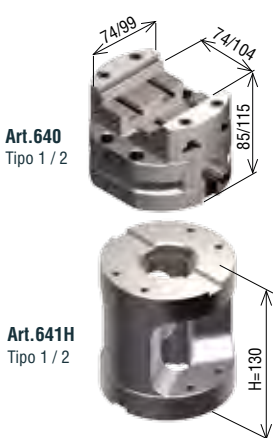

Art. 640
Tipo 1 / 2

Art. 641H
Tipo 1 / 2

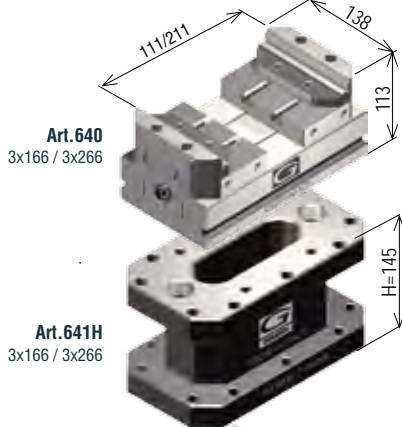

Art. 640
3x166 / 3x266

Art. 641H
3x166 / 3x266

Morsa Art.640	Tipo 1 16 kN	Tipo 2 20 kN	Tipo 3x166 30 kN	Tipo 3x266 30 kN
Cod	6.64.01000	6.64.02000	7.64.03166	7.64.03266
LISTINO PREZZI €	1.525	1.877	2.184	2.287
PREZZO SPECIALE €	1.199	1.499	1.699	1.799

Distanziale Art.641H	Tipo 1	Tipo 2	Tipo 3x166	Tipo 3x266
Cod	7.64.1H100	7.64.1H200	7.64.1H3166	7.64.1H3266
LISTINO PREZZI €	541	779	1.134	1.455
PREZZO SPECIALE €	399	499	699	899



Art. 63
Distanziale singolo
+ n.1 Zero Point



Art. 64
Distanziale doppio
+ n.2 Zero Point

Distanziali con Zero Point	Art. 63		Art. 64
	Acciaio	Alluminio	Alluminio
LISTINO PREZZI €	1.700	1.800	3.042
PREZZO SPECIALE €	1.300	1.370	2.400

* Sul prezzi di listino attuali



SCADENZA
31 Luglio 2016

Multiflex, Il sistema modulare più completo al mondo



FMS MORSE MODULARI DI PRECISIONE

Specifiche per centri di lavoro orizzontali e verticali

Risparmia fino al **23%**

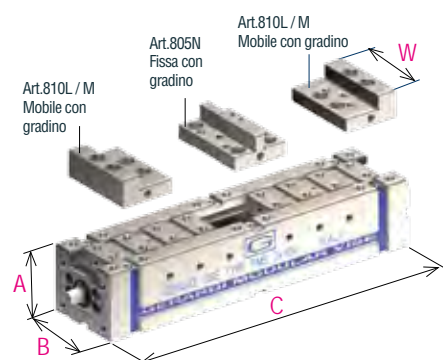
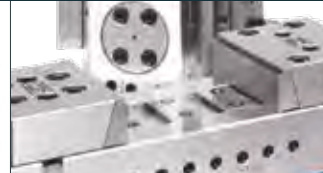

Art. 863

Morsa doppia singola autocentrante con ganasce a gradino

Dotazione standard: 1 Chiave a pipa, 2 tasselli di posizionamento e 2 arresti laterali +

In omaggio:  n. 4 staffe Art. 298

Tipo di morsa W	2 (94mm) - 25kN		3 (124mm) - 30kN		4 (144mm) - 30kN	
Altezza base A	90	90	90	100	100	120
Larghezza base B	95	95	95	125	125	145
Lunghezza base C	400	500	600	500	600	600
Cod	5.85.52400	5.85.52500	5.85.52600	5.85.53500	5.85.53600	5.85.54600
PREZZO LISTINO Corpo base Art.855 €	1.120	1.519	1.677	1.456	2.014	1.856
PREZZO SPECIALE base body Art.855 €	1.049	1.199	1.299	1.399	1.599	1.799
Cod	5.86.32400	5.86.32500	5.86.32600	5.86.33500	5.86.33600	5.86.34600
PREZZO LISTINO Complete Vise Art.863 €	1.603	2.001	2.159	1.989	2.546	2.550
PREZZO SPECIALE Morsa Completa Art.863 €	1.499	1.699	1.799	1.799	2.099	2.199

Con l'acquisto dell' **Art.863** a scelta una ganasca intermedia a **METÀ PREZZO !**

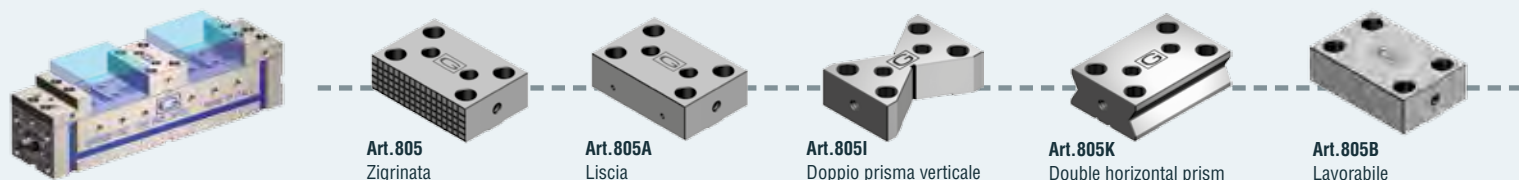

Al prezzo di **Art.863 + €65** anziché €127 + 1 ganasca intermedia **Art.805G** a **METÀ PREZZO !**

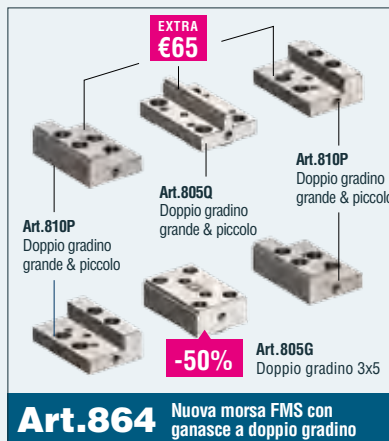

Art.864 Nuova morsa FMS con ganasce a doppio gradino

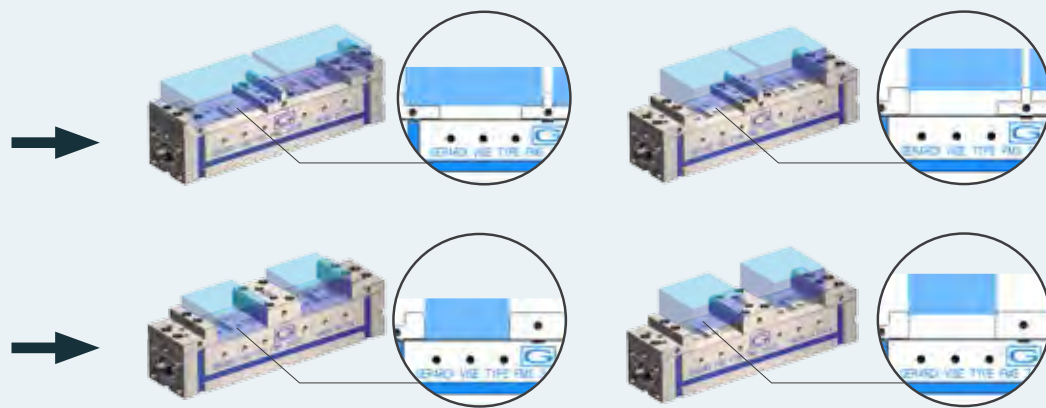

Morsa Autocentrante con Ganasce Alte

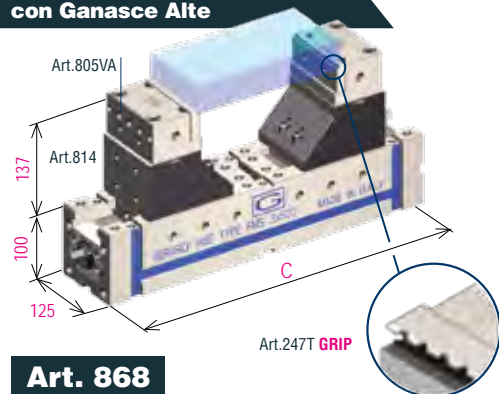

Art. 868

Morsa autocentrante (opzione doppia o singola) con ganasce alte. Ideale per centri di lavoro a 5 assi

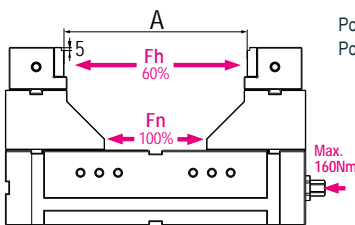

Possibilità di utilizzo di qualsiasi ganasca fissa FMS anziché del corpo ganasca 805V
Possibilità di due posizioni per ciascuna ganasca fissa e per base ganasca mobile Art.814

Omaggio:  n. 4 staffe Art. 298

Dot. Std: 1 Chiave a pipa, 2 tasselli di posizionamento e 2 arresti laterali

Tipo di morsa W	3 (124mm) - 30kN	
Apertura Massima A	334	444
Lunghezza base C	500	600
Cod.	5.86.83500	5.86.83600
PREZZO LISTINO €	1.792	2.235
PREZZO OFFERTA €	1.434	1.788



SCADENZA
31 Luglio 2016

Il Sistema Modulare Più Completo al Mondo



Cubi Portapezzi

Fusioni in ghisa monoblocco sgrossata con doppio trattamento di distensione

Risparmia fino al **31%**



5th FACCIA LAVORABILE

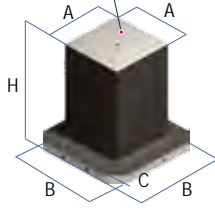

Art.53B

Cod.	A	B	C	H	kg	LISTINO PREZZI	OFFERTA SPECIALE
8.53.B00081	260	400	45	660	228	1.740	1.490
8.53.B00105	260	500	45	750	283	2.038	1.750
8.53.B00171	360	500	45	700	356	2.708	2.050
8.53.B00211	510	630	45	860	631	4.768	3.300

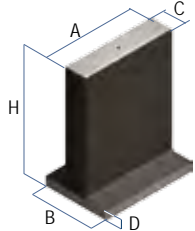

Art.55B

Cod.	A	B	C	D	H	kg	LISTINO PREZZI	OFFERTA SPECIALE
8.55.B00052	400	400	160	50	660	244	1.907	1.550
8.55.B00053	500	500	160	50	700	331	2.548	2.050
8.55.B00172	630	630	210	55	850	545	4.215	3.290
8.55.B00190	800	450	160	65	800	732	4.725	3.790

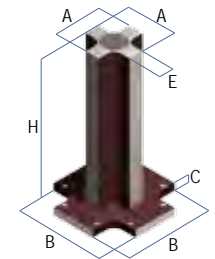

Art.57B

Cod.	A	B	C	E	H	kg	LISTINO PREZZI	OFFERTA SPECIALE
8.57.B00100	203	500	40	80	750	157	1.252	1.090
8.57.B00110	273	500	40	80	850	235	1.697	1.450
8.57.B00120	233	500	40	110	850	218	1.750	1.490
8.57.B00140	303	630	40	150	950	327	2.228	1.890

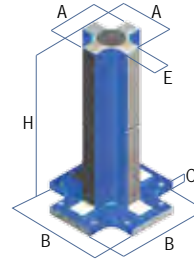

Art.57G

Cod.	A	E	H	kg	LISTINO PREZZI	OFFERTA SPECIALE
8.57.G00100	200	80	750	157	1.683	1.490
8.57.G00110	270	80	850	235	2.475	2.190
8.57.G00120	230	110	850	218	2.320	2.090
8.57.G00140	300	150	950	327	3.069	2.790

Cubi-Morse integrali con piastra base

Portapezzi con morse

Divisore Automatico DPG-250

NEW

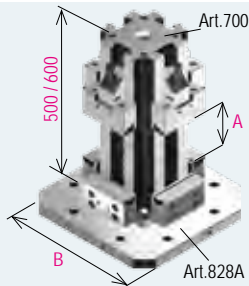

Art.700 + 828A - Cubi-Morse modulari serie STD con base personalizzata

Tipo 3 A 270 B 400	Tipo 3 A 270 B 500
€ 4.247	€ 4.735
€ 3.399	€ 3.799
Tipo 3 A 370 B 400	Tipo 3 A 370 B 500
€ 4.636	€ 5.127
€ 3.699	€ 4.099

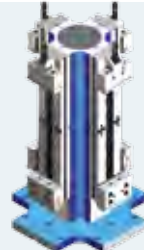

Cubo Art.57G con morse STD & XL

Cod: 8.57.G00120 ideali per morse STD / XL Tipo 2
Cod: 8.57.G00140 ideali per morse STD / XL Tipo 3-4

Montaggio ed Allineamento Centesimale Compresi nel Prezzo



2 Anni di Garanzia!

Chiavi in Mano!
- Necessaria potenza 220V per l'installazione

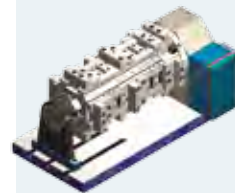

Cubo Art.57G con morse FMS

Cod: 8.57.G00120 ideali per morse FMS Tipo 2
Cod: 8.57.G00140 ideali per morse FMS Tipo 3-4

Montaggio ed Allineamento Centesimale Compresi nel Prezzo

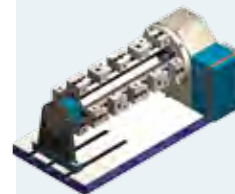

Cubo Art.57G con morse MULTIFLEX

Cod: 8.57.G00100
Cod: 8.57.G00110 ideali per MULTIFLEX Tipo 1-2
Cod: 8.57.G00120 ideali per morse MULTIFLEX Tipo 3

Montaggio ed Allineamento Centesimale Compresi nel Prezzo

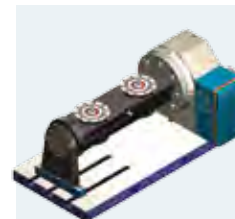

- Facile e veloce programmazione tramite schermo touch o funzione "M"

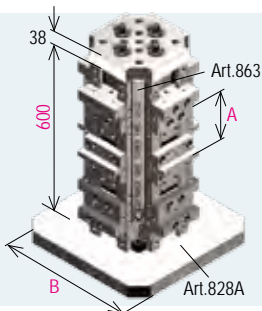

Art.863C + 828A - Cubi-Morse modulari serie FMS con base personalizzata

Tipo 3 A 2 x 262 B 400	Tipo 3 A 2 x 262 B 500
€ 12.547	€ 13.035
€ 9.999	€ 10.399

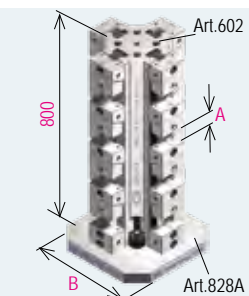

Art.602 + 828A - Cubi-Morse modulari serie MULTIFLEX con base personalizzata

Tipo 2 A 4 x 112 B 400	Tipo 2 A 4 x 112 B 500
€ 9.763	€ 10.251
€ 7.799	€ 8.199



SCADENZA 31 Luglio 2016

Cubi in ghisa + morse in acciaio = Stabilità e Precisione

5



Pneumatico Zero Point

Tempi di attrezzaggio ridotti del 90%

Risparmia fino al **29%**

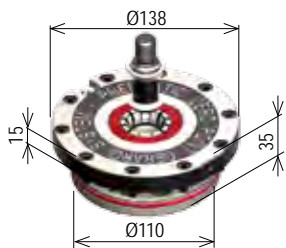

Art. 665 Tipo 2

PNEUMATICO

Montaggio incassato

Standard 10kN

Cod. 8.66.52000

LISTINO PREZZI € 676

PREZZO SPECIALE € 499

Fino a 18kN*



Dotazione Standard: 1 tirante Art.10 - 1 tappo teflon con O-Ring Art.9

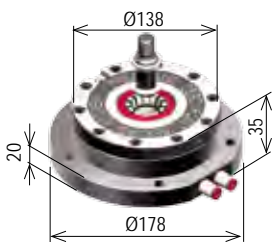

Art. 664 Tipo 2

PNEUMATICO

Montaggio con flangia

Standard 10kN

Cod. 8.66.42000

LISTINO PREZZI € 780

PREZZO SPECIALE € 599

Fino a 18kN*



* Molle maggiorate **IN OMAGGIO**

con l'acquisto del moltiplicatore di pressione aria Art.408

UN INVESTIMENTO CHE SI RIPAGA VELOCEMENTE

TEMPI DI AMMORTAMENTO RIDOTTISSIMI !!

- Riattrezzaggi velocissimi, praticamente istantanei
- Preparazione dei particolari da lavorare fuori macchina
- Drastica riduzione di possibili sbagli dovuti al posizionamento
- Tipicamente l'utilizzo di Zero Point su 3 centri di lavoro crea tanta capacità quanto un nuovo centro di lavoro. (per circa solo il 15% del costo)

Art. 81P

2 unità Art. 665 + piastra base 200 x 400

P. LISTINO € 1.863

P. OFFERTA: € 1.399



L'investimento si ripaga in meno di 1 mese

*** Calcoli basati su un costo orario medio di € 40,00, 2 ore al giorno di attrezzamento e 50 settimane lavorative con un conseguente profitto potenziale extra di € 18.000,00

Kit Piastre base interfacciate con Zero Point pneumatici + Piastre d'interfaccia lisce

KIT #1

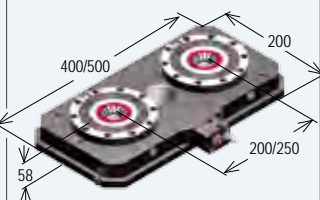

Art. 81P con Art.665 (2pcs)	PIASTRA BASE 200x400 200x500
LISTINO PREZZI €	1.863 1.938
PREZZO SPECIALE €	1.399 1.499

KIT #2

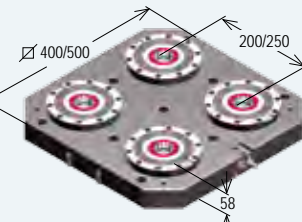

Art. 80P con Art.665 (4pcs)	PIASTRA BASE 400x400 500x500
LISTINO PREZZI €	3.719 4.051
PREZZO SPECIALE €	2.799 2.999

KIT #3

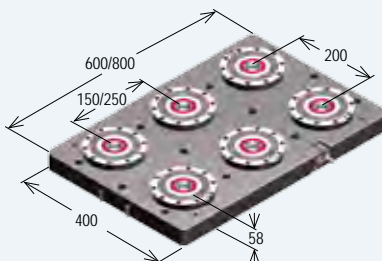

Art. 81P con Art.665 (6pcs)	PIASTRA BASE 400x600 400x800
LISTINO PREZZI €	5.516 5.800
PREZZO SPECIALE €	4.199 4.399

KIT #4

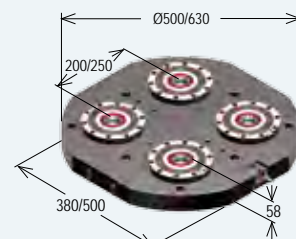

Art. 82P con Art.665 (4pcs)	PIASTRA BASE TONDA Ø500 Ø630
LISTINO PREZZI €	4.124 4.651
PREZZO SPECIALE €	3.199 3.599

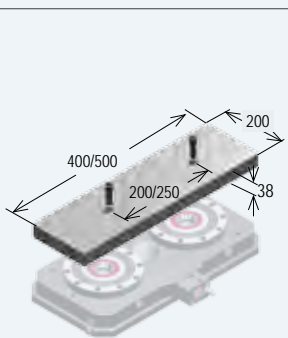

Art. 61i con Art.10A (2pcs)	PIASTRA D'INTERFACCIA 200x400 200x500
LISTINO PREZZI €	650 750
PREZZO SPECIALE €	499 599

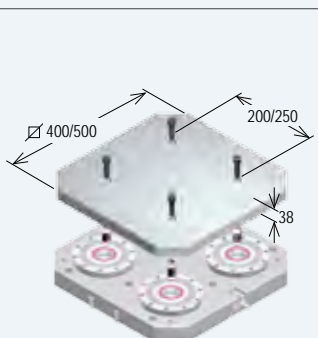

Art. 60i con Art.10A (4pcs)	PIASTRA D'INTERFACCIA 400x400 500x500
LISTINO PREZZI €	936 1.144
PREZZO SPECIALE €	699 899

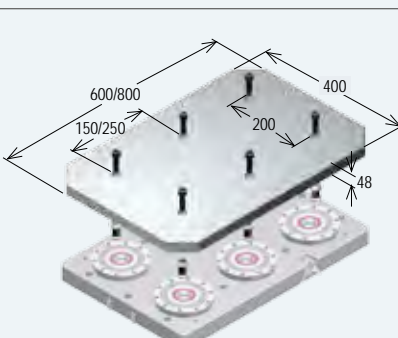

Art. 61i con Art.10A (6pcs)	PIASTRA D'INTERFACCIA 400x600 400x800
LISTINO PREZZI €	1.404 1.924
PREZZO SPECIALE €	999 1.399



Art. 62i con Art.10A (4pcs)	PIASTRA D'INTERFACCIA TONDA Ø500 Ø630
LISTINO PREZZI €	1.199 1.599
PREZZO SPECIALE €	949 1.299



SCADENZA
31 Luglio 2016

Posizionamento e ancoraggio istantaneo



Classic Line

Teste angolari Integrali

Maggior rigidità e compattezza grazie all'albero e cono integrali

Made in Italy

ATC Serie (Cambio utensile automatico)

Modello	Uscita	Rpm Max	Nm	LISTINO PREZZI €	Tipo 1 (Ø90)			
G90-7	ER-11	6.000	5	3.198				
G90-7L	ER-11	6.000	5	3.358				
G90-10	ER-16	6.000	7	2.808				
G90-10L	ER-16	6.000	7	3.510	7	7L	10	10L
G90-16	ER-25	4.000	24	2.999				
G90-16L	ER-25	4.000	24	4.220				
GMU-13	ER-20	4.000	6	3.813				
GMU-16	ER-25	4.000	18	4.012	16	16L	GMU13	GMU16

					Tipo 2 (Ø110)			
G90-20	ER-32	4.000	40	3.620				
G90-20L	ER-32	4.000	40	4.525				
GMU-20	ER-32	4.000	32	4.298	20	20L	GMU20	

Modello	Uscita	Rpm Max	Nm	LISTINO PREZZI €	Tipo 3 (Ø170)	
G90-S40	ISO40 / CAT / BT40	4.000	140	5.216		
G90-S40L	ISO40 / CAT / BT40	4.000	140	6.390	S40	S40L

MTC Serie (Cambio Utensile Manuale)

Modello	Uscita	Rpm Max	LISTINO PREZZI €	MODELLI			
G90-S40XL	ISO/CAT/ BT40	4.000	6.390				
G90-S40XL_xx	ISO/CAT/ BT40	4.000	a richiesta				
G90-S50	ISO/CAT/ BT50	3.000	10.480				
G90-S50XL_xx	ISO/CAT/ BT50	3.000	a richiesta	S40XL	S40XLxx	S50XL	S50XLxx
GMU-16	ER-25	4.000	3.750				
GMU-20	ER-32	4.000	4.053				
GMU-S40	ISO/CAT/ BT40	3.000	7.727				
GMU-S50	ISO/CAT/ BT40	3.000	18.410	GMU16	GMU20	GMUS40	GMUS50

Evolution Line

Moltiplicatori e Teste angolari Modulari

Coni intercambiabili per un utilizzo su più centri di lavoro

Made in Italy

ATC Serie (Cambio utensile automatico)

Modello	Uscita	Rpm Max	Nm	LISTINO PREZZI €	Tipo 1 (Ø102)			
FS90-3	6023E	8.000	2	4.230				
FS90-3L	6023E	8.000	2	4.720				
FS90-4	600E	8.000	3,5	3.910				
FS90-4L	600E	8.000	3,5	4.530	3	3L	4	4L
F90-7	ER-11	10.000	6	3.245				
F90-7L	ER-11	10.000	6	3.690				
F90-10	ER-16	10.000	11	2.760				
F90-10L	ER-16	10.000	11	3.425				
F90-16S	ER-25	8.000	27	3.390				
FMU-10	ER-16	4.000	9	3.445				
FMU-16	ER-25	3.000	15	3.690	16S	FMU10	FMU16	

Modello	Uscita	Rpm Max	Nm	LISTINO PREZZI €	Tipo 2 (Ø128)		
F90-16	ER-25	5.000	46	3.400			
F90-16L	ER-25	5.000	46	4.100			
F90-20	ER-32	3.500	85	3.800	16	16L	20

Modello	Uscita	Rpm Max	Nm	LISTINO PREZZI €	Tipo 3 (Ø157)	
F90-S40	SK/ BT40	2.500	135	4.400		
FMU-20	ER-32	2.500	48	4.650	S40	FMU20

MOLTIPLICATORI DI GIRI

Modello	i	Uscita	Rpm Max	LISTINO PREZZI €	MODELLI		
GSS-10HS	1:8	ER-16	35.000	4.720			
GSS-10	1:6	ER-16	22.000	2.400			
GSS-13	1:6	ER-20	22.000	2.600			
GSS-16	1:6	ER-25	15.000	3.220	GSS 10HS	GSS 13-10	GSS 16
GSS-20	1:6	ER-32	12.000	3.730			
GSS-26	1:4,2	ER-40	10.000	7.890			
GSS-34	1:4	ER-50	8.000	10.410			
					GSS 20	GSS 26	GSS 34



SCADENZA
31 Luglio 2016

Una vasta gamma di teste angolari per centri di lavoro e macchine tradizionali



Motorizzati

Made in Italy

Risparmia
fino al
32%

SCADENZA IL
31 Luglio 2016



Vdi din 69880

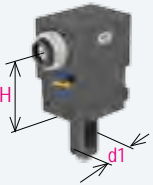

DIN 5480

Disponibili anche:
DIN5482 - BARUFFALDI - DIN1809

d1	Cod	ER	H	Nm	Rpm	LISTINO PREZZO €	PREZZO SPECIALE €
30	99.ST.8003	25	66	32	5000	864	699
	99.ST.8011	25	66	32	5000	1.116	849
40	99.ST.8005	32	95	63	4000	1.080	799
	99.ST.8013	32	95	63	4000	1.412	1.099

d1	Cod	ER	H	Nm	Rpm	LISTINO PREZZO €	PREZZO SPECIALE €
30	99.ST.8030	25	55	32	5000	1.814	1.399
	99.ST.8038	25	55	32	5000	2.088	1.599
40	99.ST.8033	32	100	63	4000	2.296	1.699
	99.ST.8041	32	100	63	4000	2.636	1.999

▼ Senso di rotazione contrario al mandrino

Bmt 55/65

Compatibili con: DOOSAN - HARDINGE - SAMSUNG
HWACHEON - HYUNDAI WIA - VICTOR

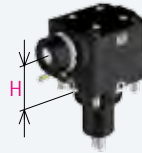

BMT	Cod	ER	H	Nm	Rpm	LISTINO PREZZO €	PREZZO SPECIALE €
55	99.DS.A01	25	Max 57,2	40	8000	1.020	699
	99.DS.A02	25	Max 57,2	40	8000	1.170	799
65	99.DS.A41	32	Max 72,5	70	6000	1.200	880
	99.DS.A42	32	Max 72,5	70	6000	1.380	999

BMT	Cod	ER	H	Nm	Rpm	LISTINO PREZZO €	PREZZO SPECIALE €
55	99.DS.A11	25	70	40	8000	1.920	1.399
	99.DS.A12	25	70	40	8000	2.268	1.650
65	99.DS.A51	32	72	70	6000	2.016	1.499
	99.DS.A52	32	72	70	6000	2.388	1.749

▼ Senso di rotazione contrario al mandrino

Mazak

QUICK TURN NEXUS QTN 200/250
SUPER QUADREX TURN SQT 15/18 - 200/250



Cod	ER	H	Nm	Rpm	LISTINO PREZZO €	PREZZO SPECIALE €
99.MZ.A58	32	50	80	6000	1.560	1.299
99.MZ.A59	32	50	80	6000	2.400	1.999

Cod	ER	H	Nm	Rpm	LISTINO PREZZO €	PREZZO SPECIALE €
99.MZ.A65	32	130	80	6000	1.670	1.499
99.MZ.A66	32	130	80	6000	2.200	1.899

▼ Senso di rotazione contrario al mandrino

Dmg Mori

NL 1500 - 2000 - 2500 - 3000

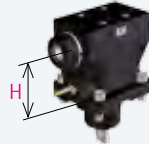
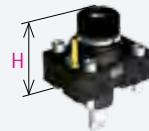

Cod	ER	H	Nm	Rpm	LISTINO PREZZO €	PREZZO SPECIALE €
99.MS.A59	32	Max 89,9	60	10000	1.176	999
99.MS.A60	32	Max 89,9	60	10000	1.740	1.549

Cod	ER	H	Nm	Rpm	LISTINO PREZZO €	PREZZO SPECIALE €
99.MS.A72	32	Max 90	60	10000	2.520	2.249
99.MS.A73	32	Max 90	60	10000	2.820	2.549

▼ Senso di rotazione contrario al mandrino

Haas

Presi di moto intercambiabile
per le varie tipologie di torrette Haas

VDI 40



In caso di ordine specificare T tipo di macchina e quota h1

Cod	ER	H	h1	Nm	Rpm	LISTINO PREZZO €	PREZZO SPECIALE €
99.HA.590082	32	81,1	117,5	63	6000	890	799
99.HA.590082B	32	81,1	117,5	63	6000	1.110	999
99.HA.590083	32	81,1	104,8	63	6000	890	799
99.HA.590083B	32	81,1	104,8	63	6000	1.110	999

Cod	ER	H	h1	Nm	Rpm	LISTINO PREZZO €	PREZZO SPECIALE €
99.HA.590084	32	75	117,5	63	6000	1.670	1.499
99.HA.590084B	32	75	117,5	63	6000	2.110	1.899
99.HA.590085	32	75	104,8	63	6000	1.670	1.499
99.HA.590085B	32	75	104,8	63	6000	2.110	1.899

▼ Senso di rotazione uguale al mandrino

Nakamura

BMT44 WT100 - TW10

SUPER NTJ-NTJX / NTM 3 / TMC 18 / TW10 /
SC150-250 / WT150-250 / WTW 150 /
WTS 150 / WT100

BMT55

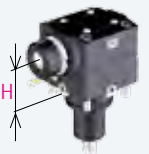
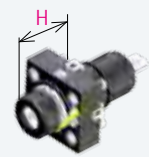

BMT	Cod	ER	H	Nm	Rpm	LISTINO PREZZO €	PREZZO SPECIALE €
44	99.NK.A40	25	Max 57,2	40	6000	891	699
	99.NK.A43	25	Max 57,2	40	6000	1.018	799
55	99.NK.A03	32	Max 72,2	63	6000	935	749
	99.NK.A04	32	Max 72,2	63	6000	1.441	1.199

BMT	Cod	ER	H	Nm	Rpm	LISTINO PREZZO €	PREZZO SPECIALE €
44	99.NK.A50	25	60	40	6000	1.579	1.299
	99.NK.A53	25	60	40	6000	1.892	1.499
55	99.NK.A13	32	55	63	6000	1.760	1.399
	99.NK.A14	32	55	63	6000	2.373	1.899

Biglia & Myano



Portautensili Statici



ER Collets & Test bar



GERARDI SPA

via Giovanni XXIII, 101
21015 LONATE POZZOLO (VA) Italia
Tel. +39.0331.303911 - Fax +39.0331.301534

gerardi@gerardispa.com - www.gerardi.it

Distributor: